

Instructions photo etched deck for revell typ IXC

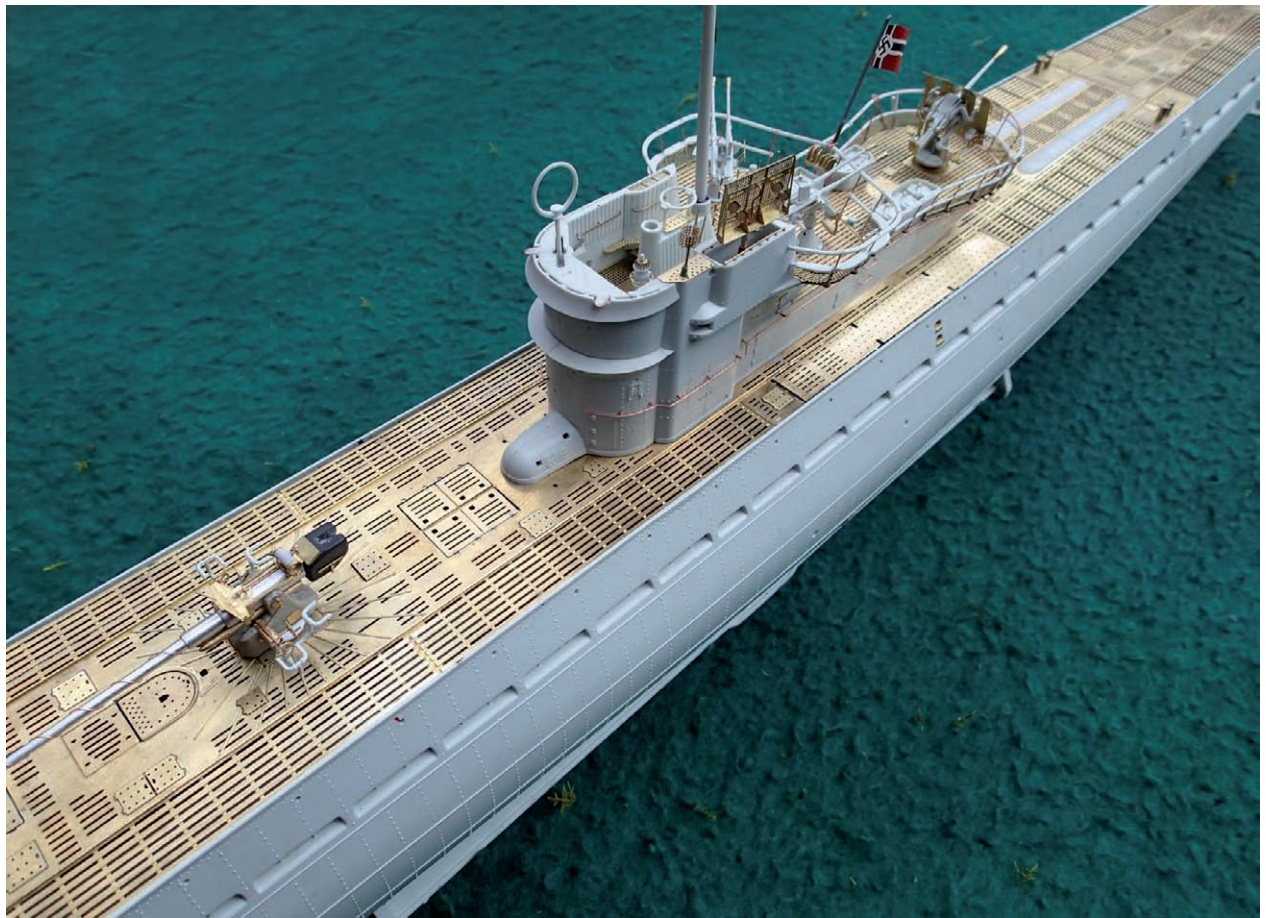

Deck

Reinforcement of the deck with a plastic foil

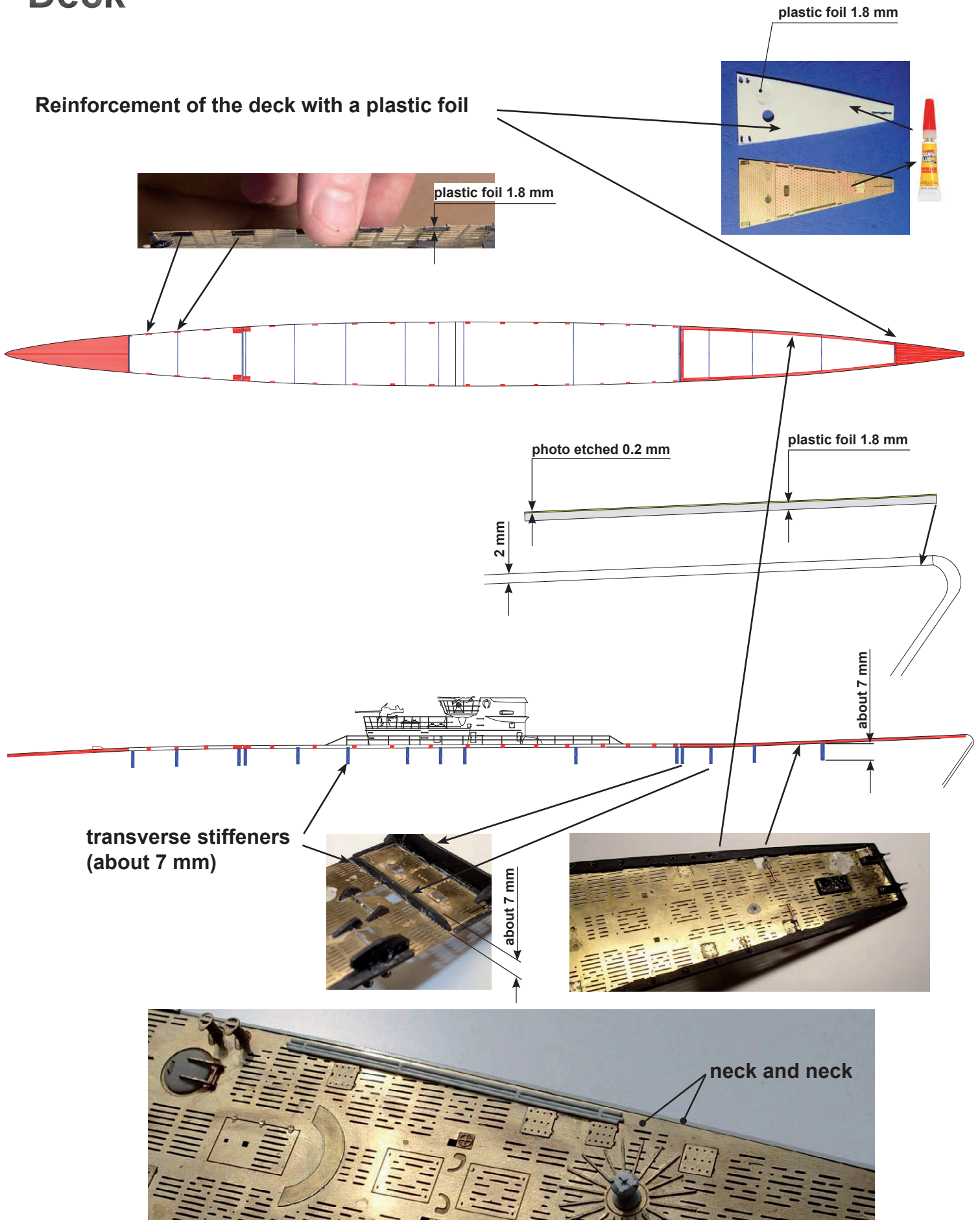

Deck A

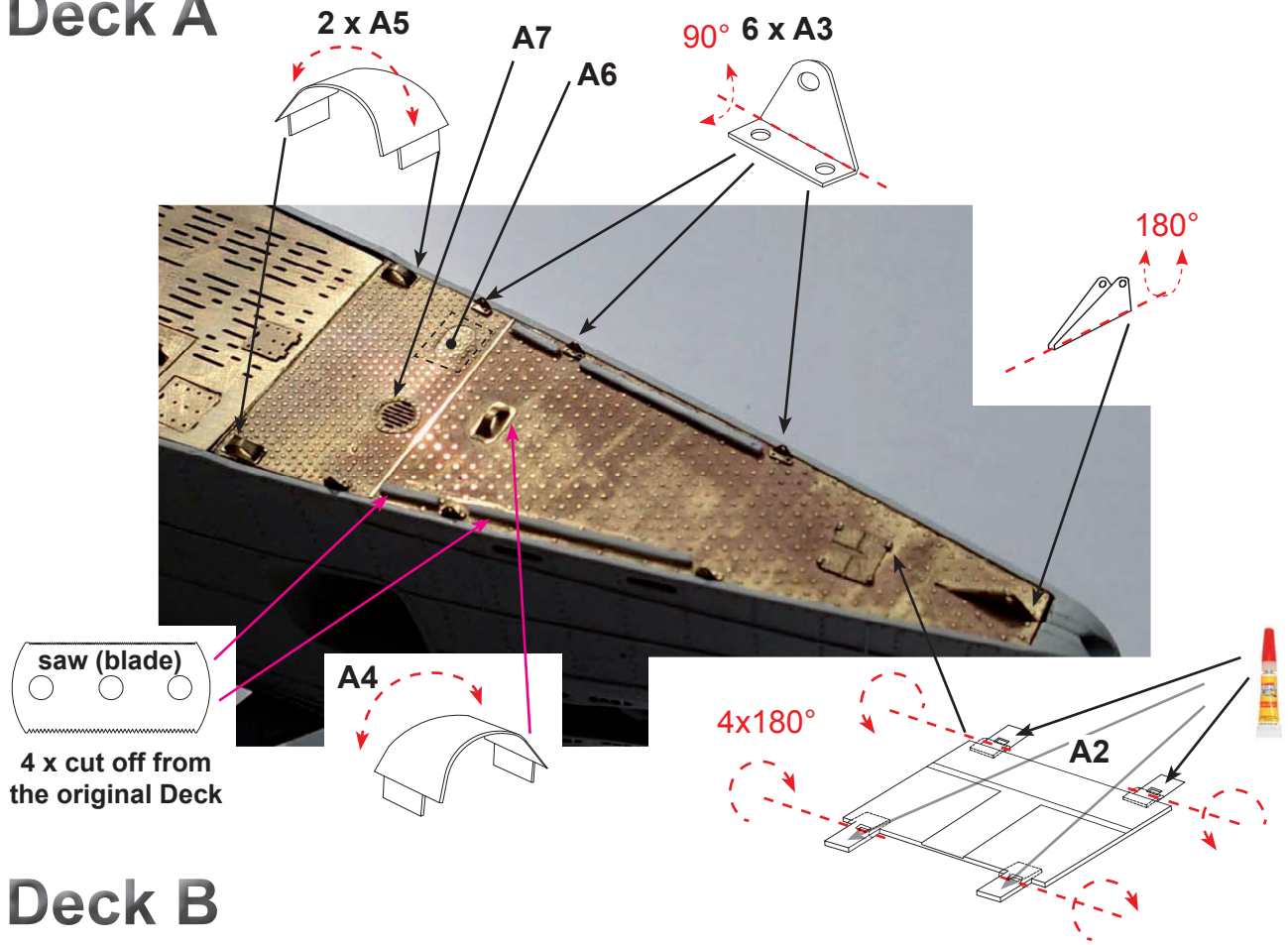

Deck B

hatches:

(B1, B2, B3, B4, B6, B7, B8, B9, B15, B16, B17, B18, C1, C2, C3, C5, E0, E3, E4, E6, I8)

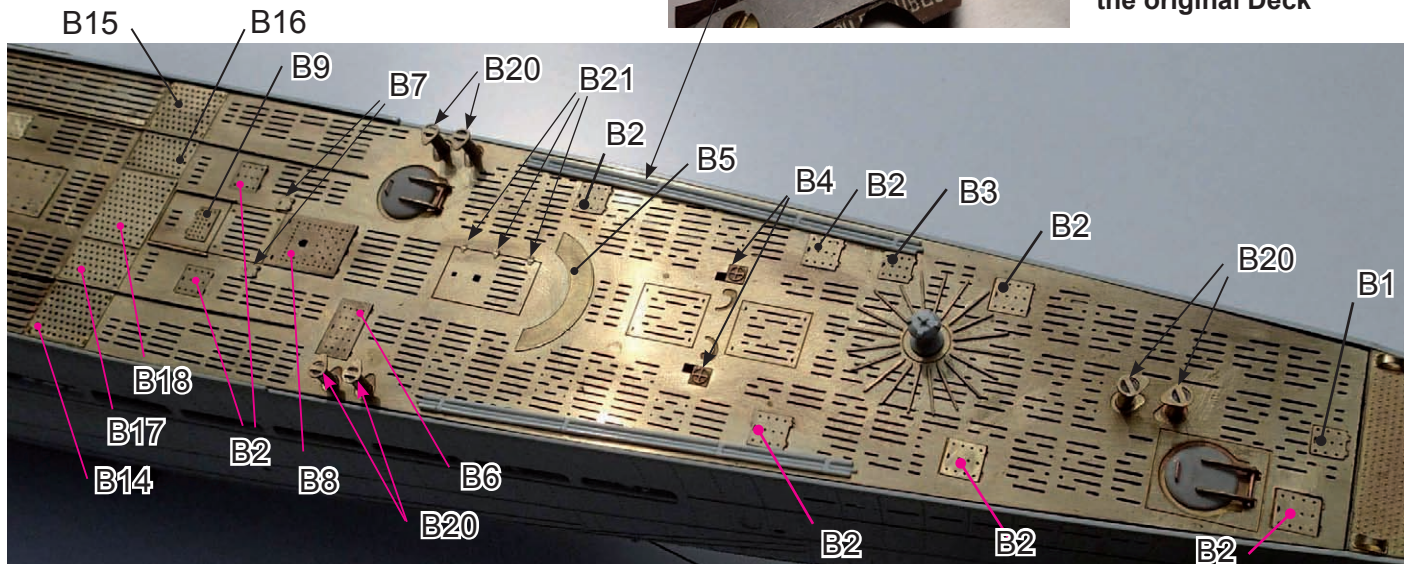
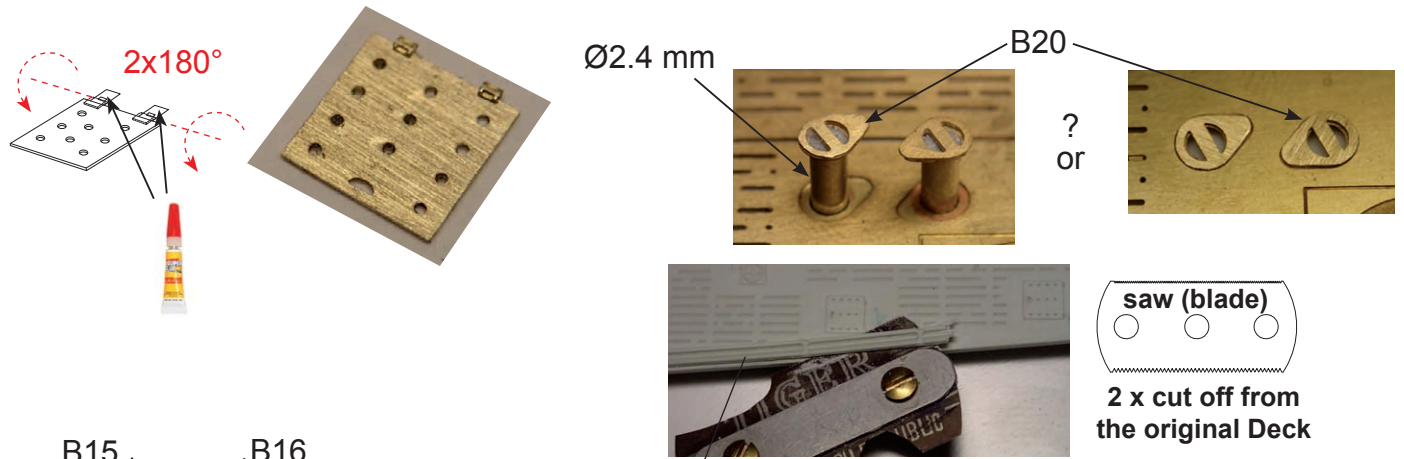

circular hatch:

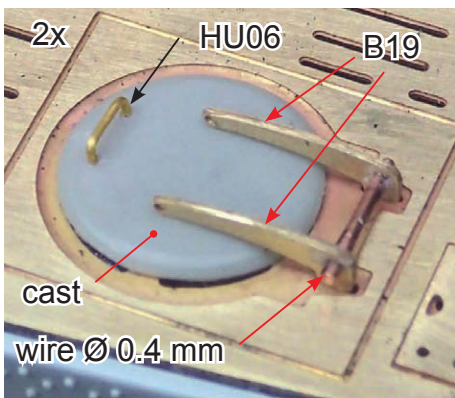

anchoring:

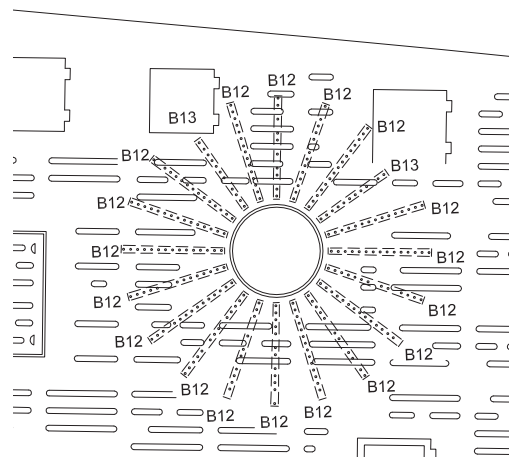
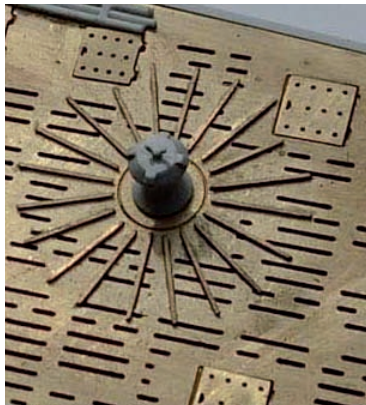

Caution, no cut up !!!

rails:
(B10, B11, C8, D2, D3, E7)

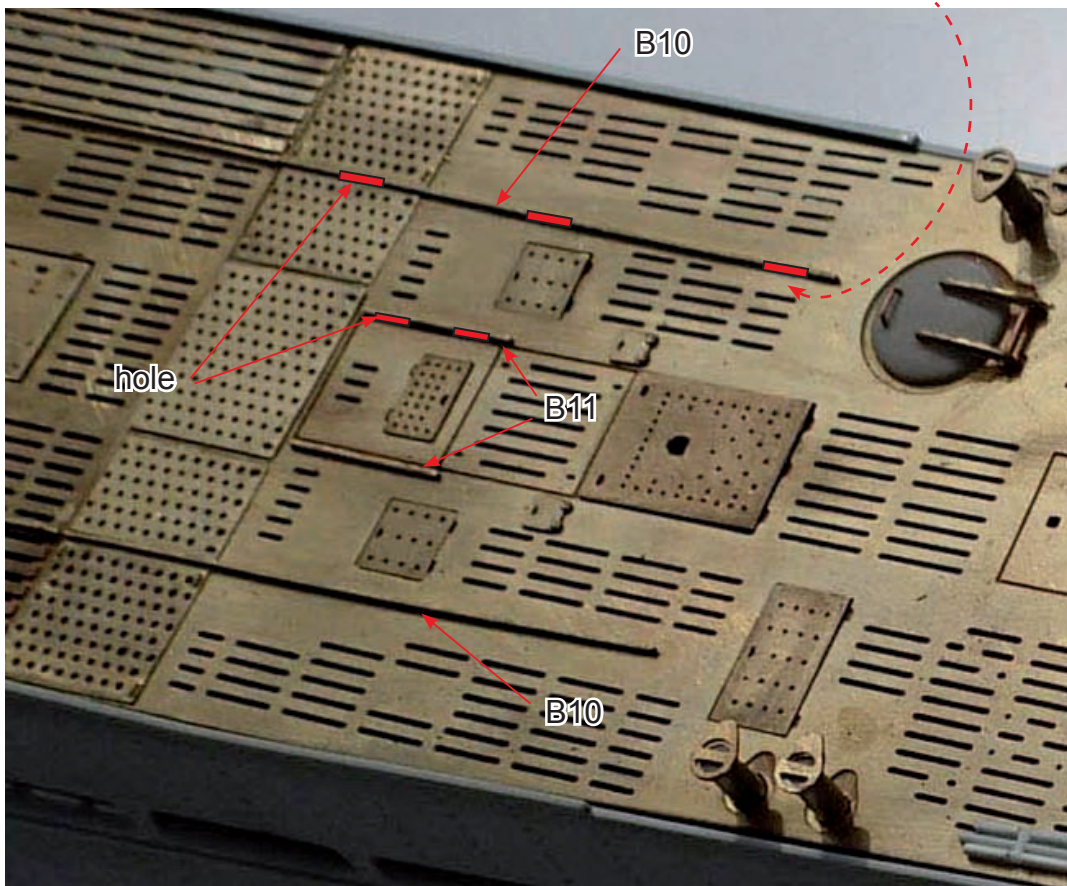
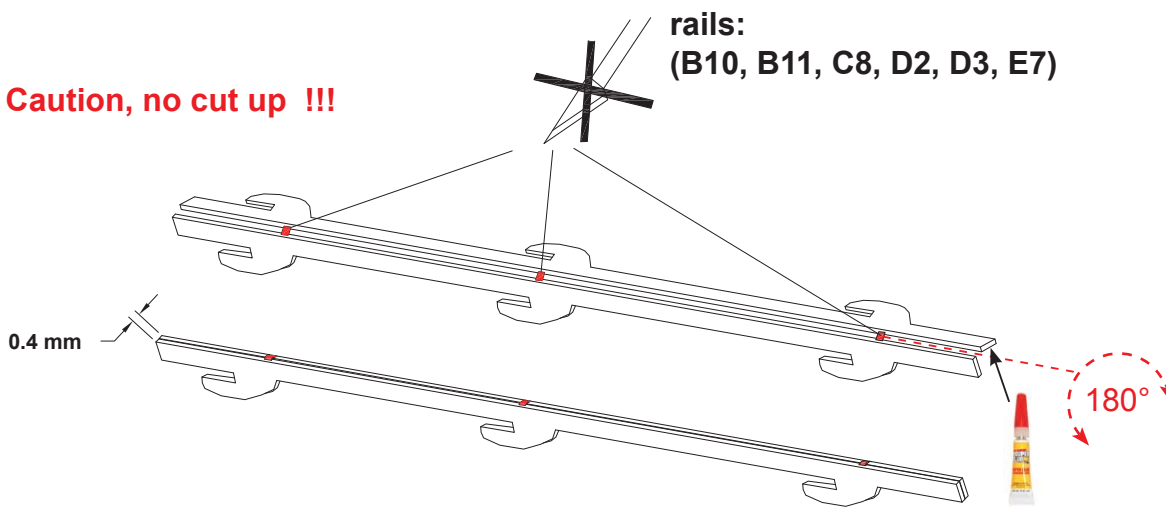

Deck C

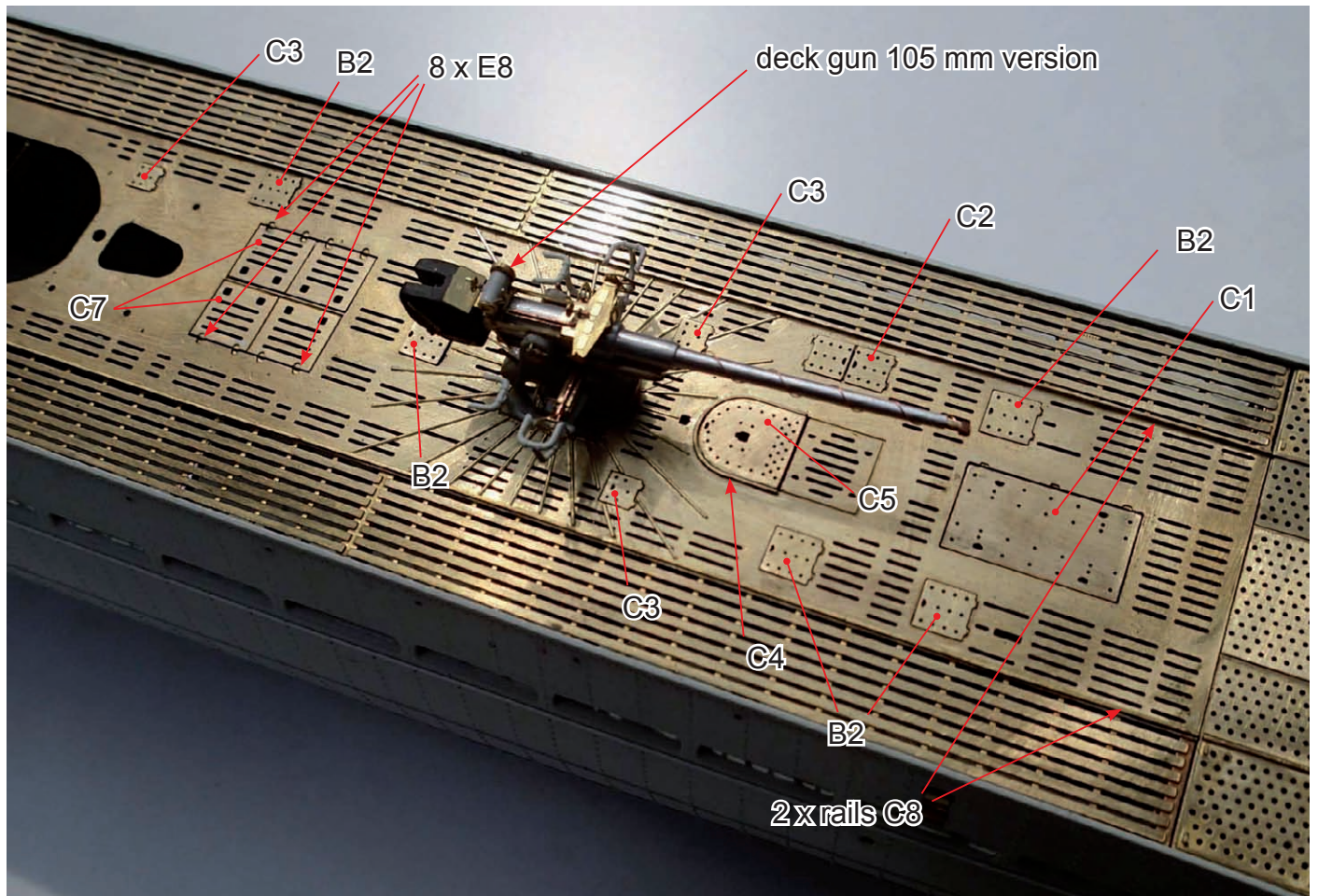

version without the deck gun

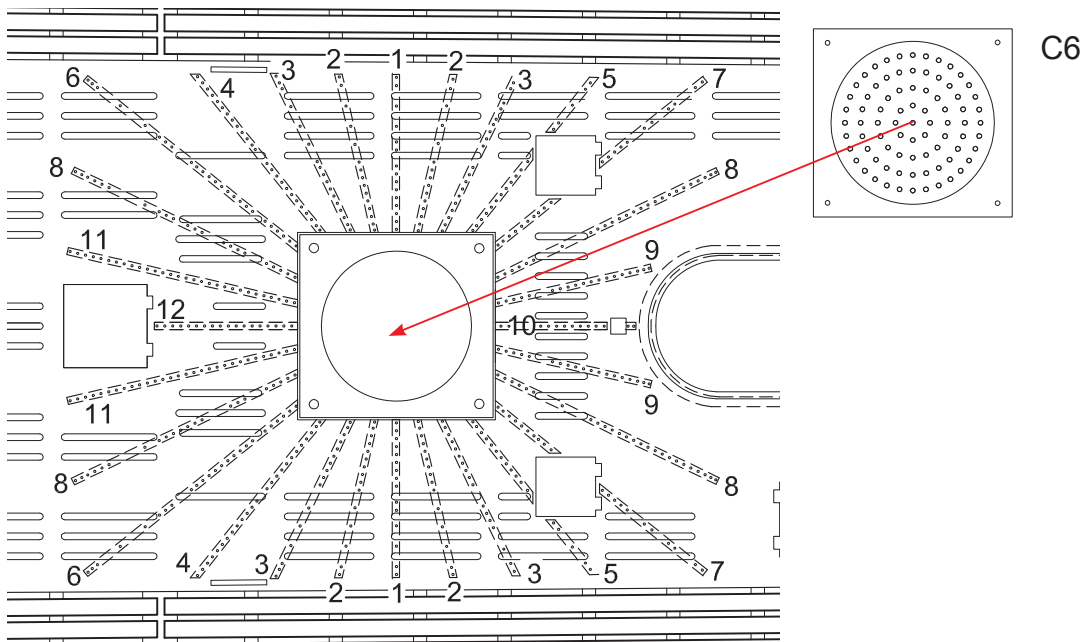

Deck C / D

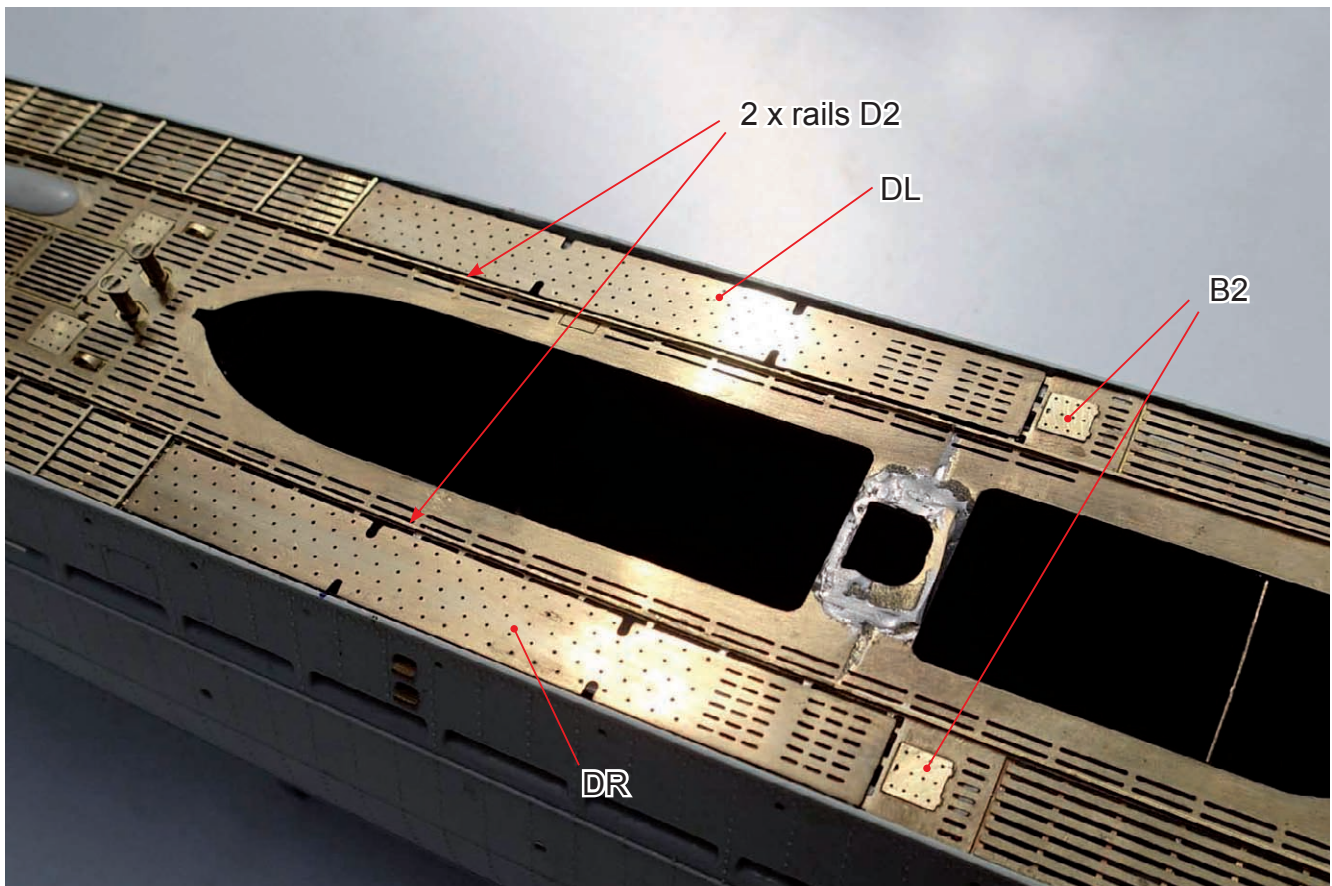

Deck D

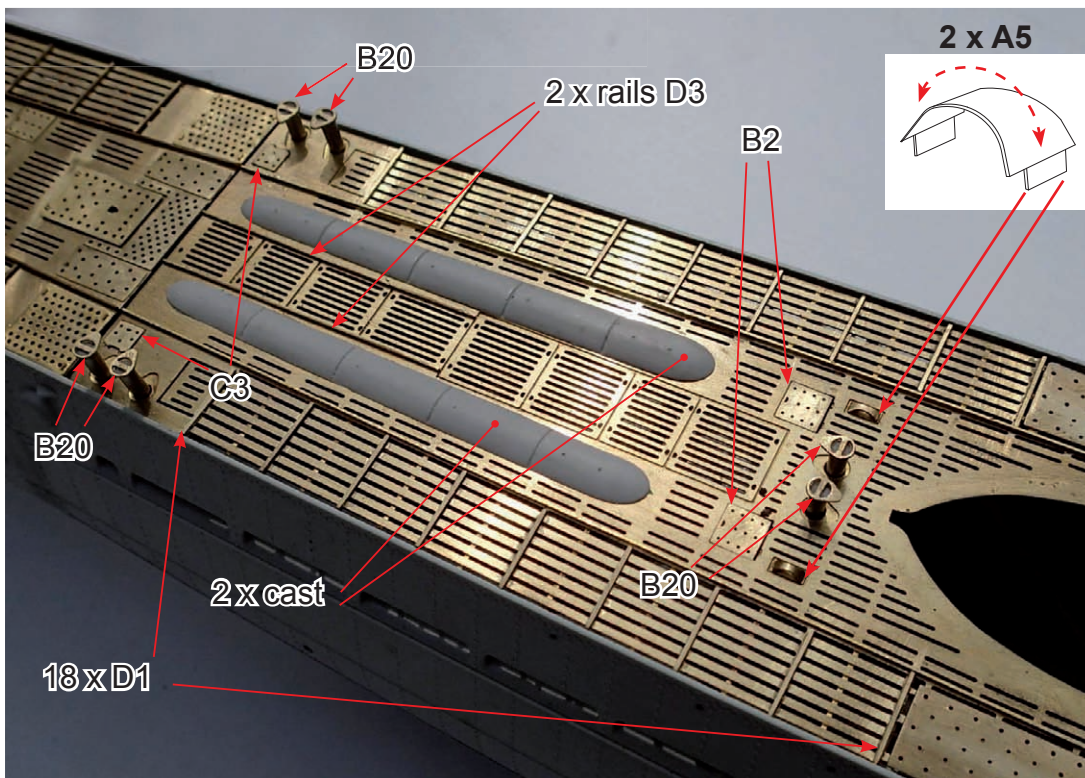

Deck E

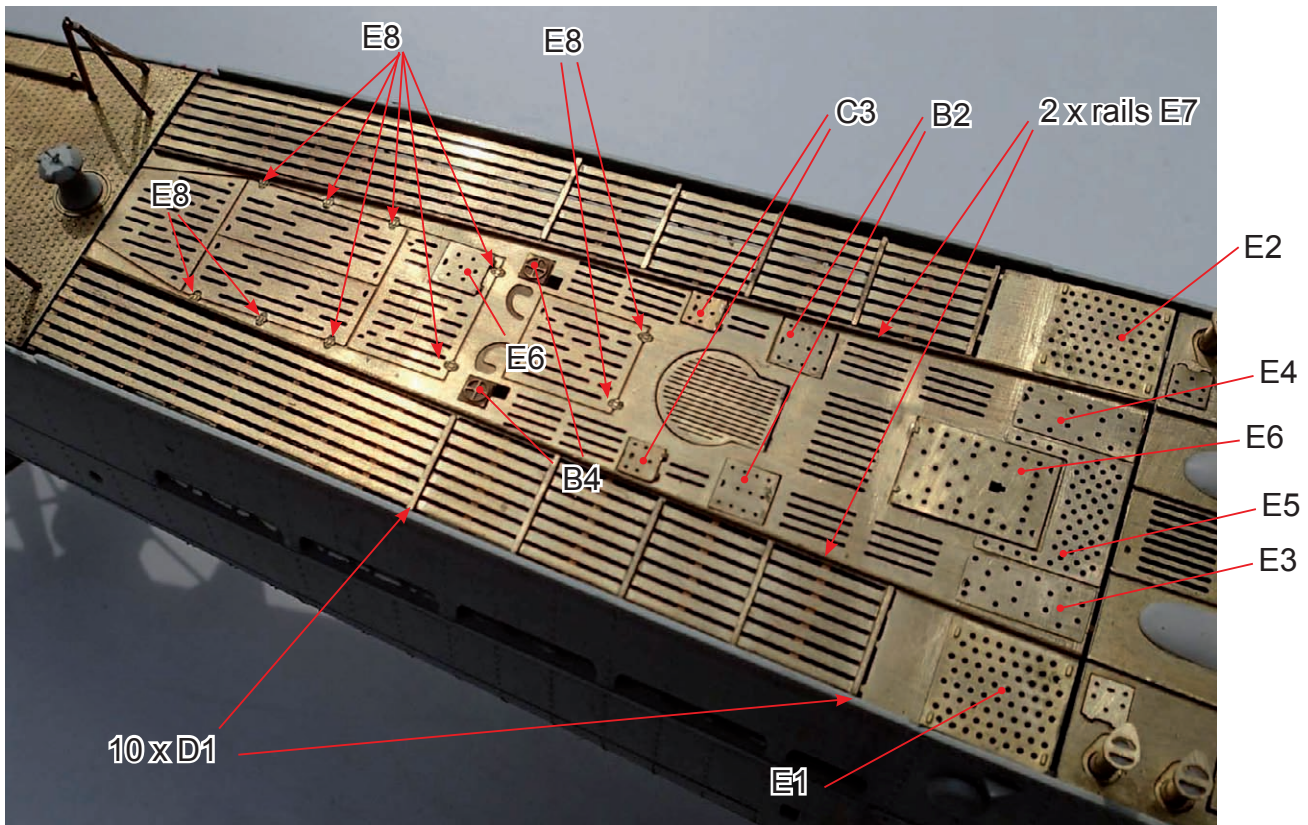

Deck F

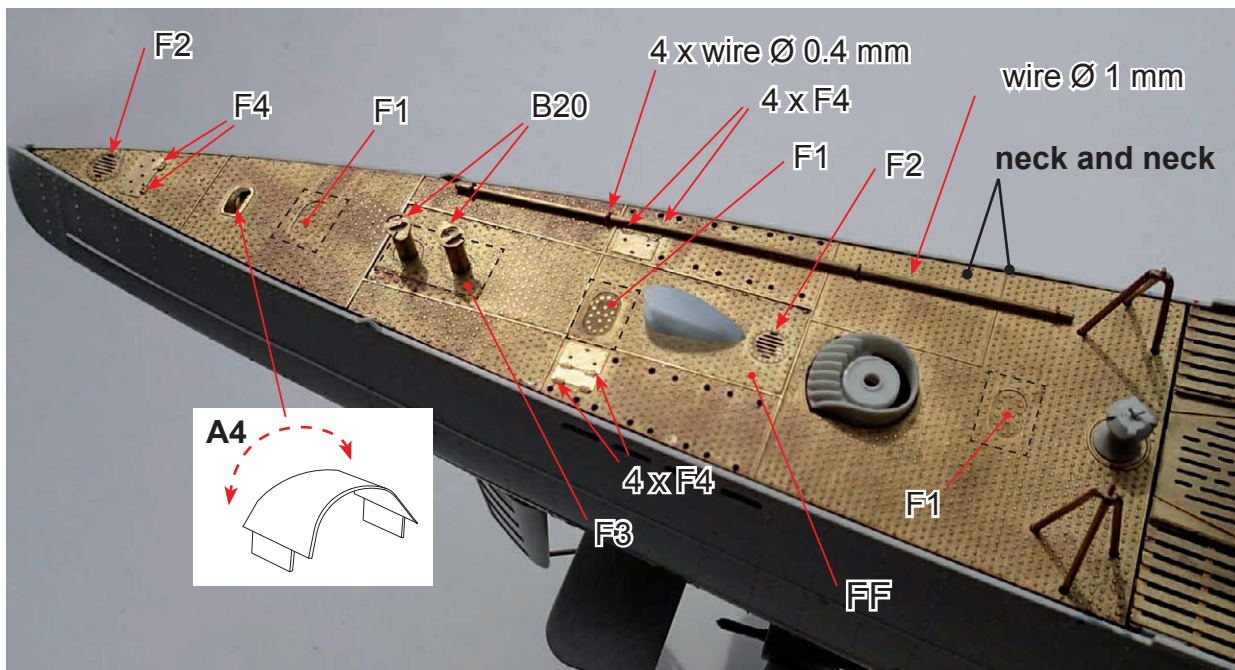

Tower, Deck G / H / I

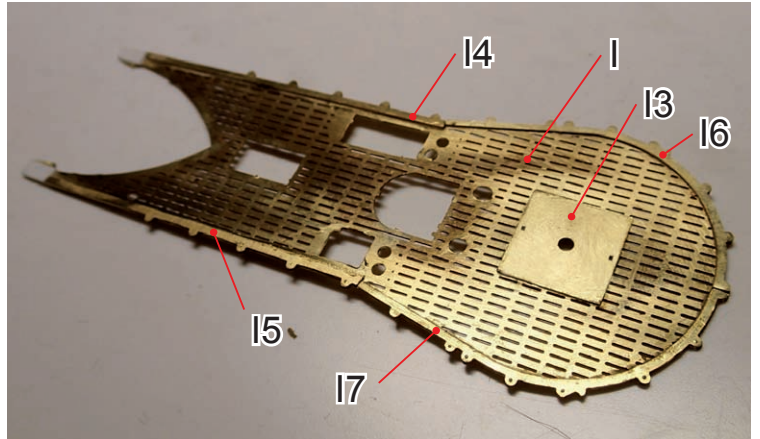
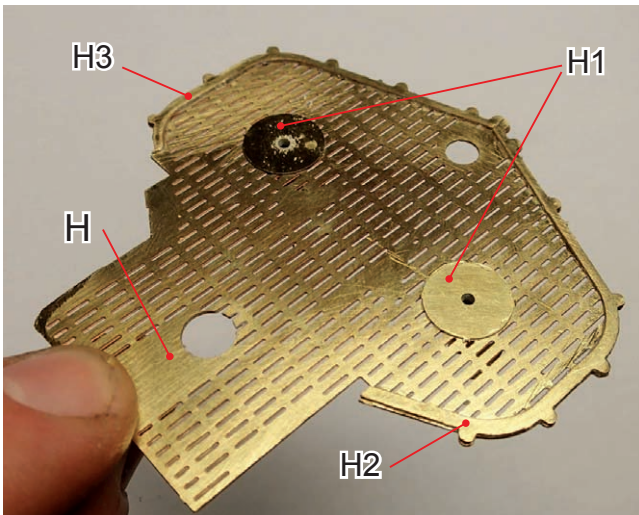

bottom of page

Revell parts B 141

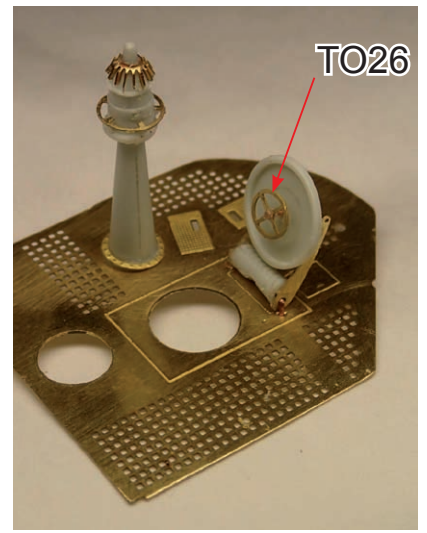
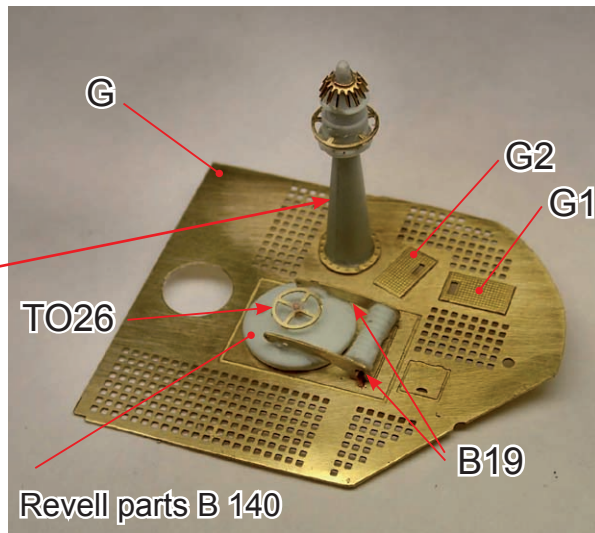
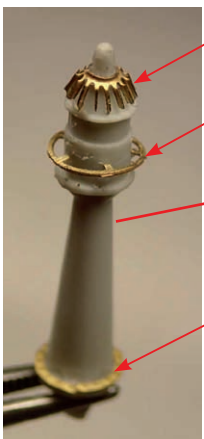

TO3 2 x 180°

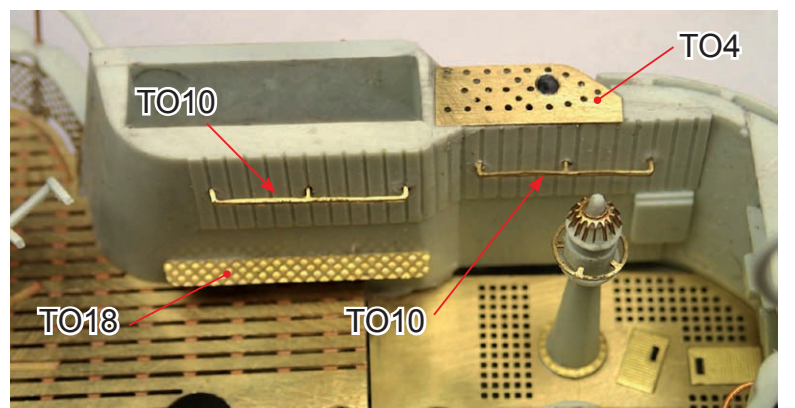
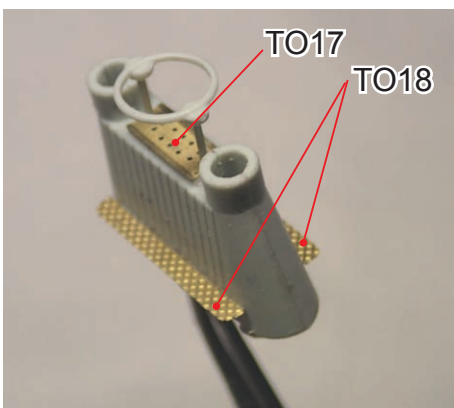
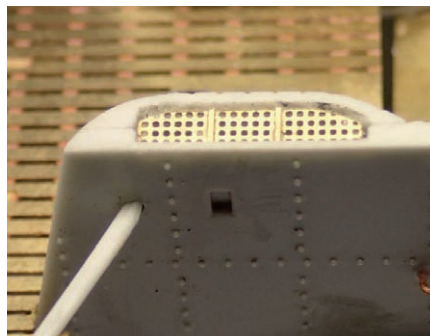
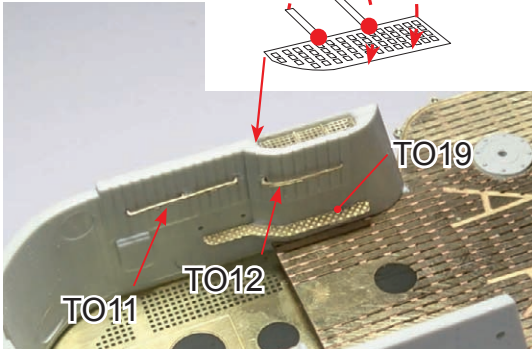

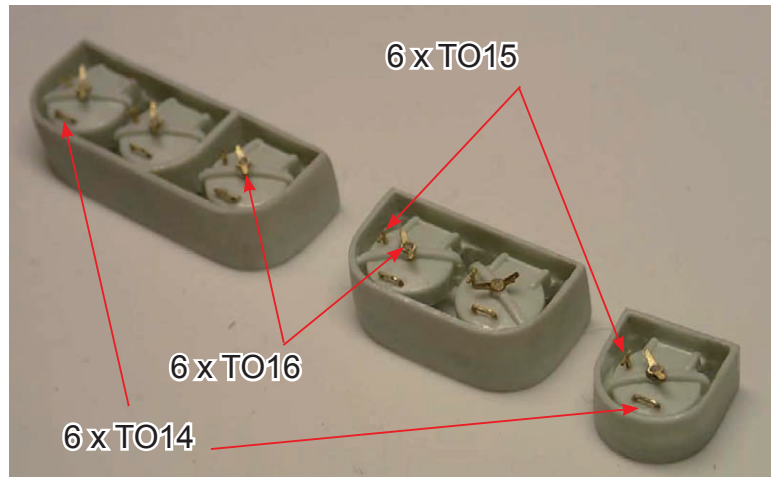

Mesh

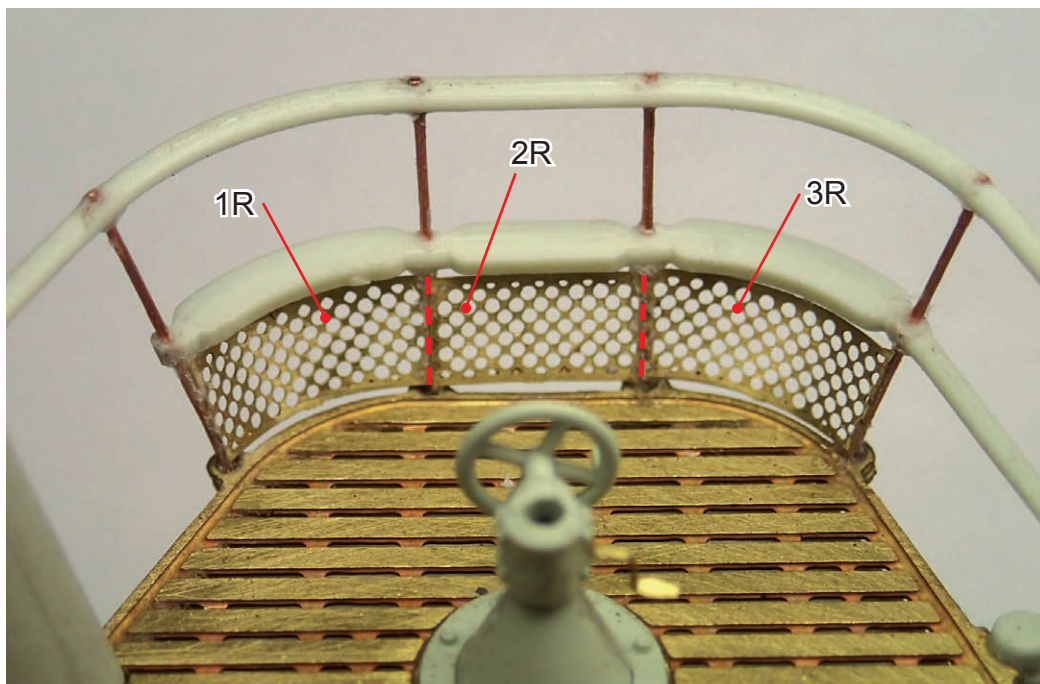
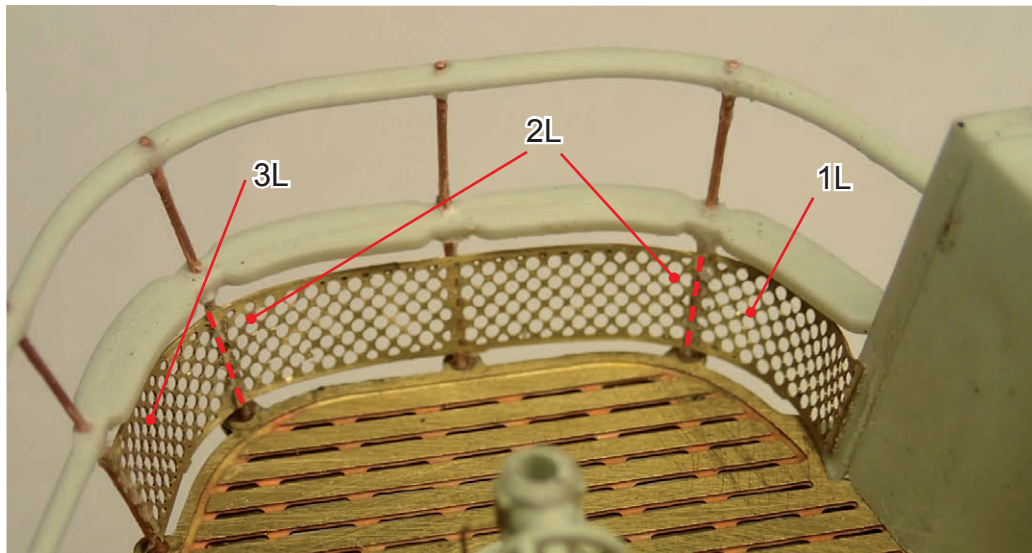

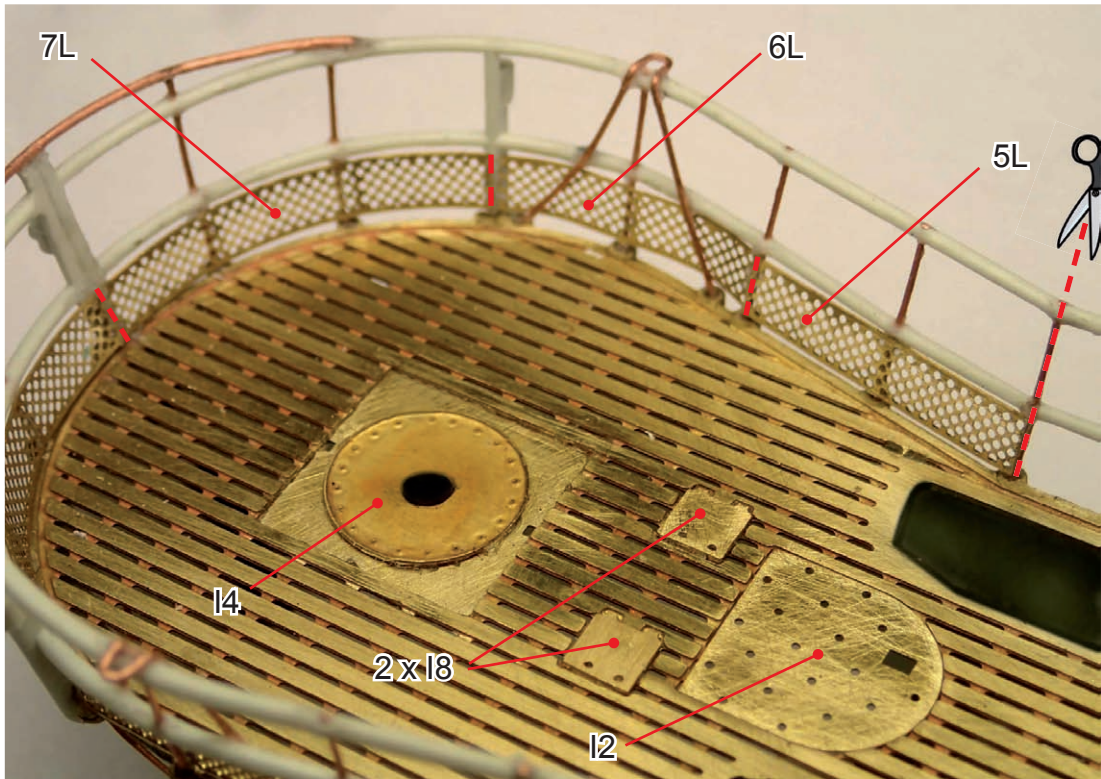
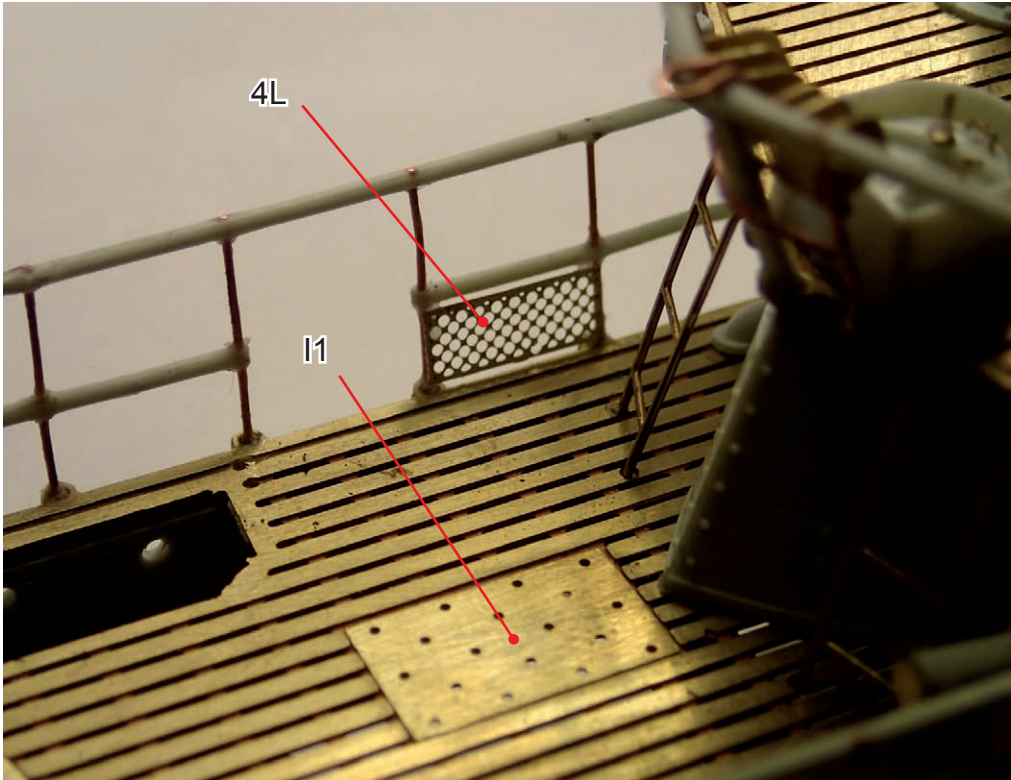

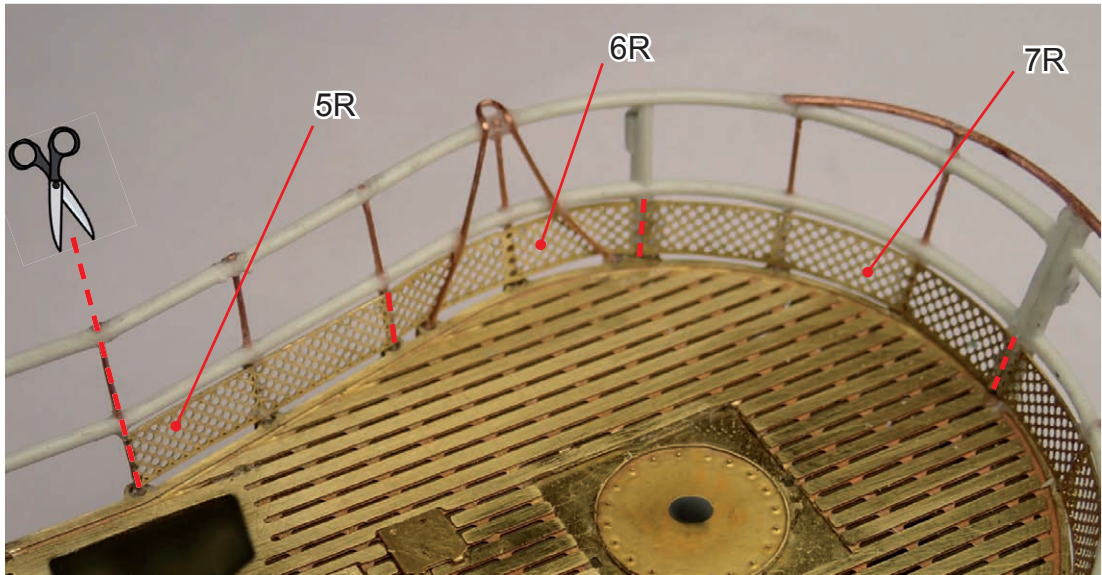
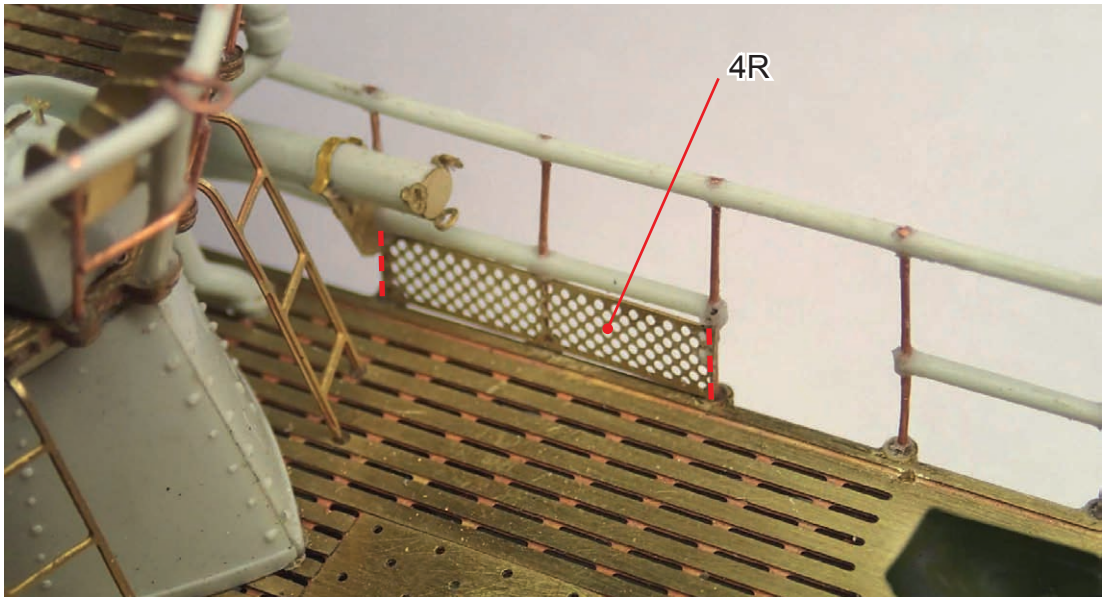

Details on the tower

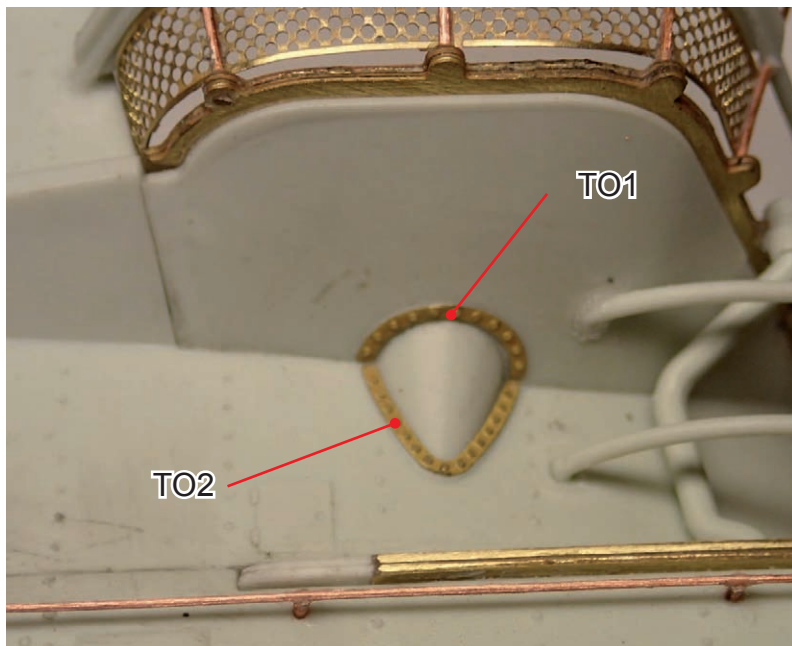

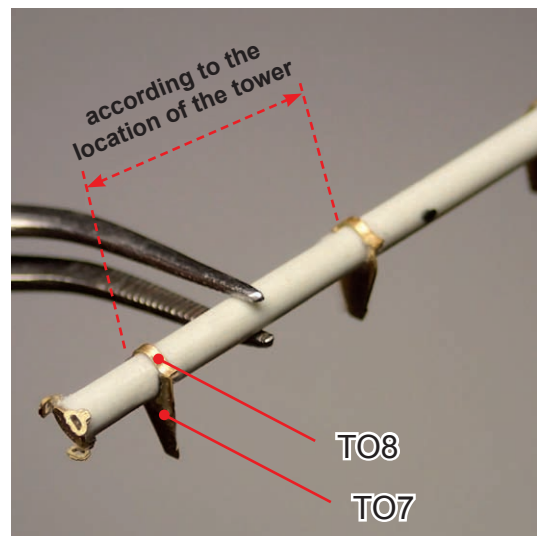
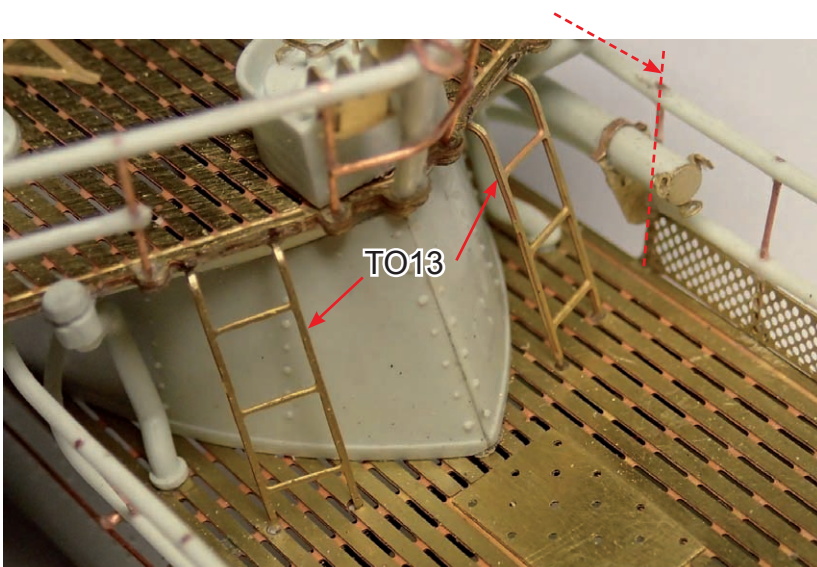
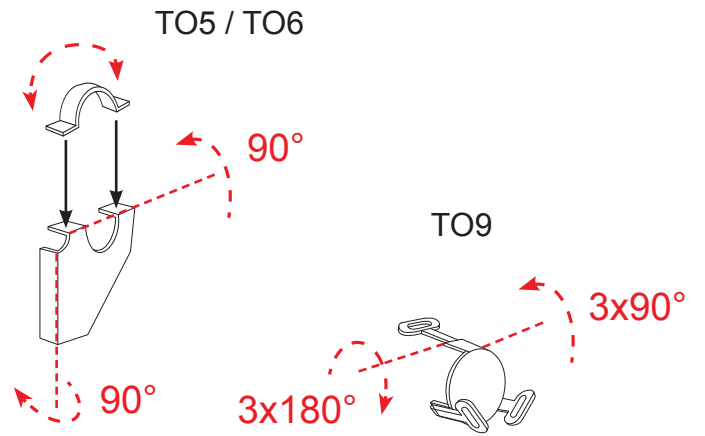
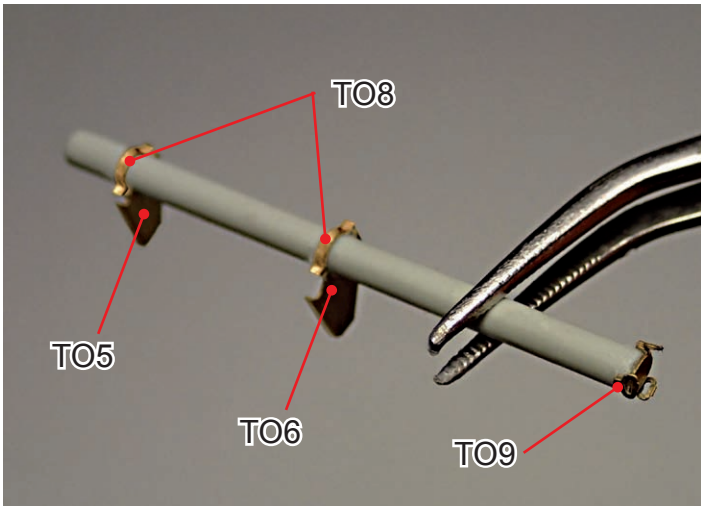
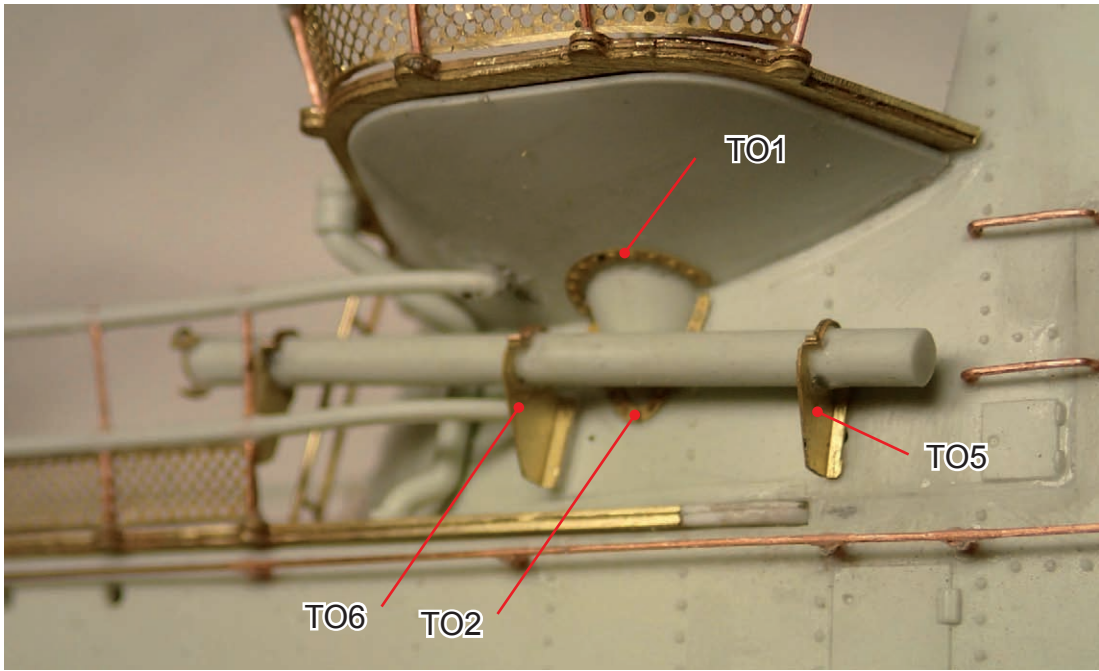

Radar

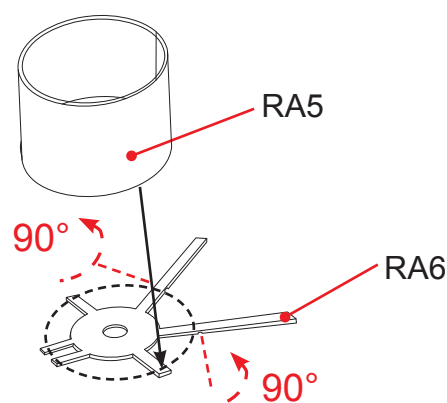
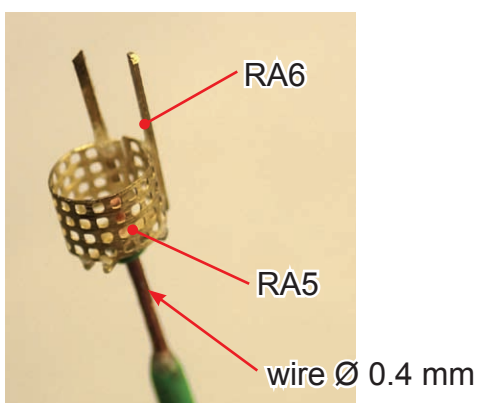
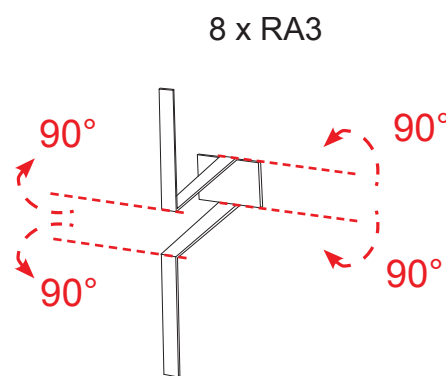
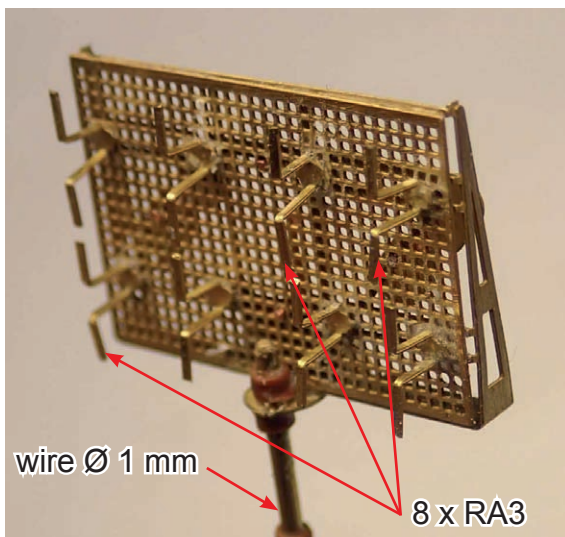
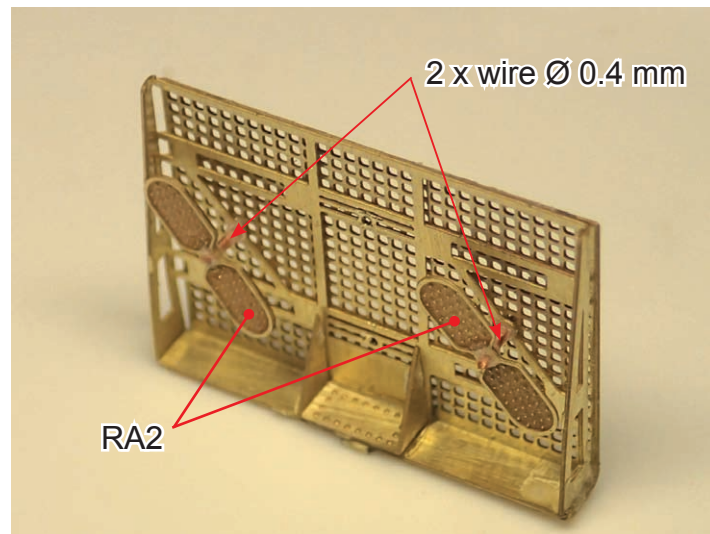
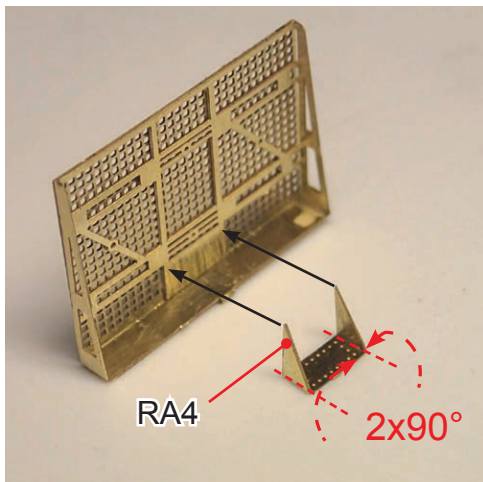
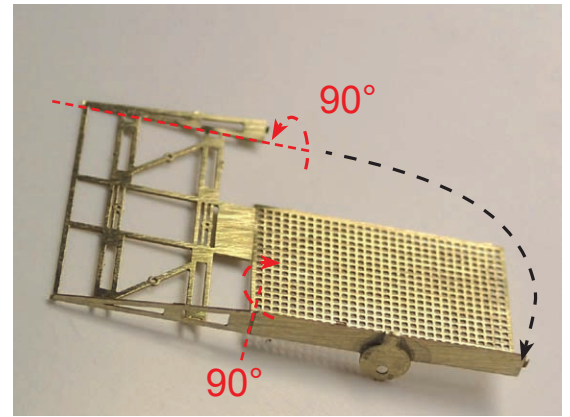
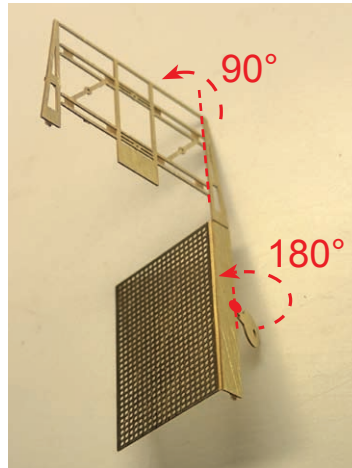
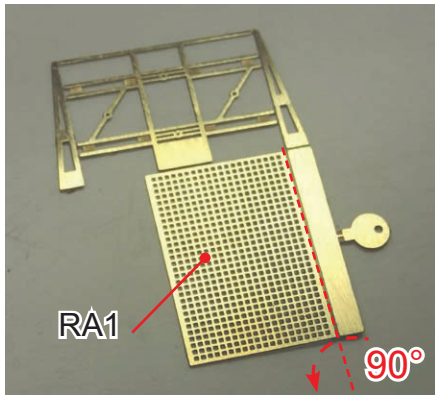

Gun 37 mm

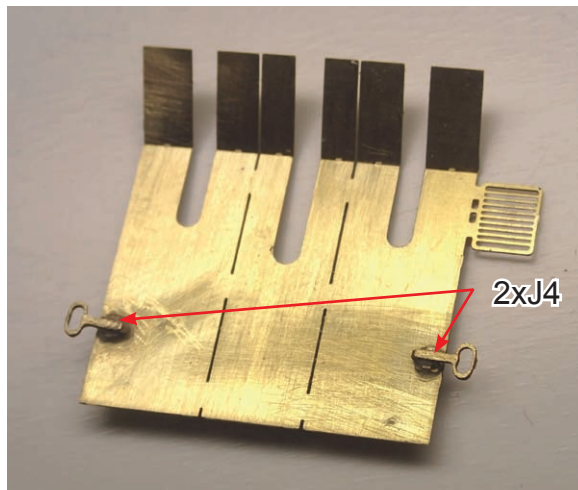
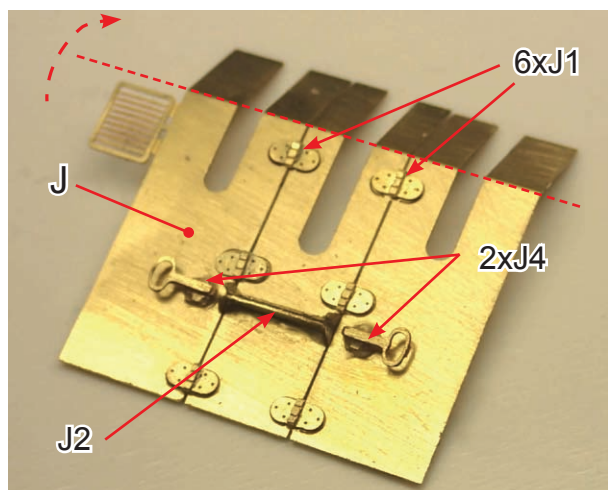
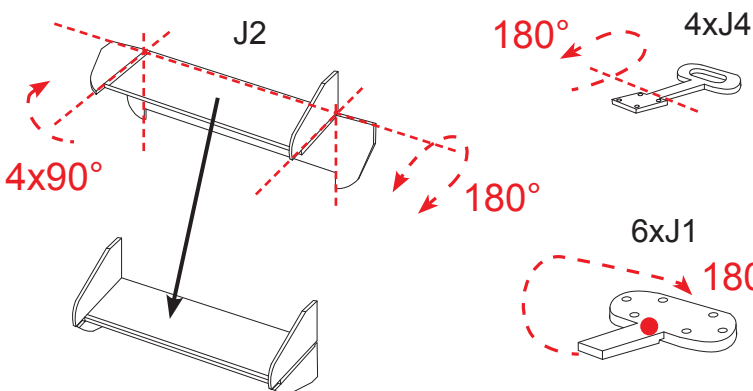
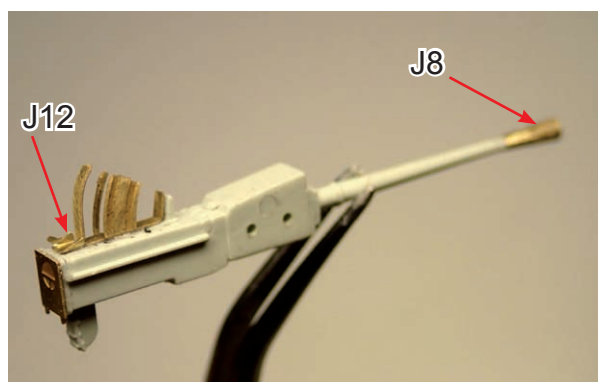
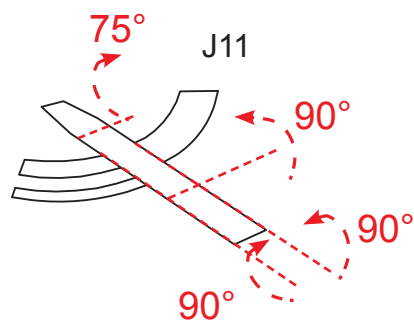
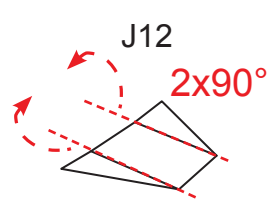
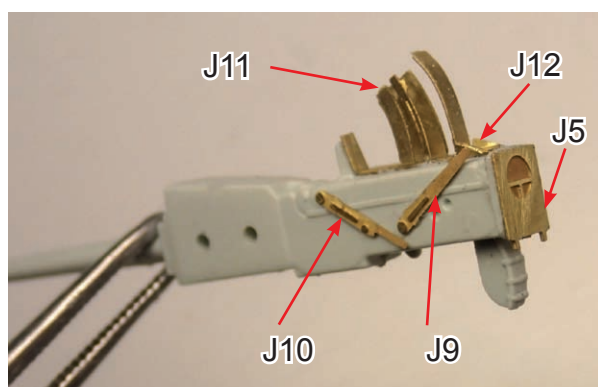
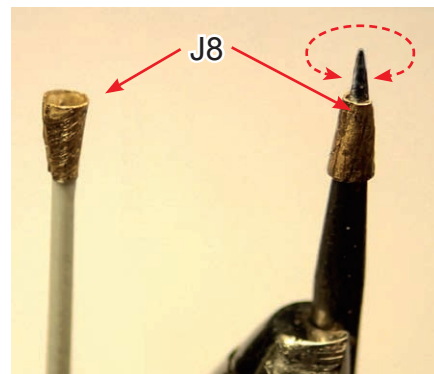
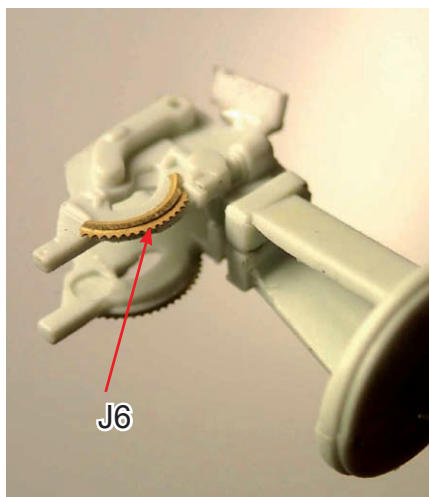
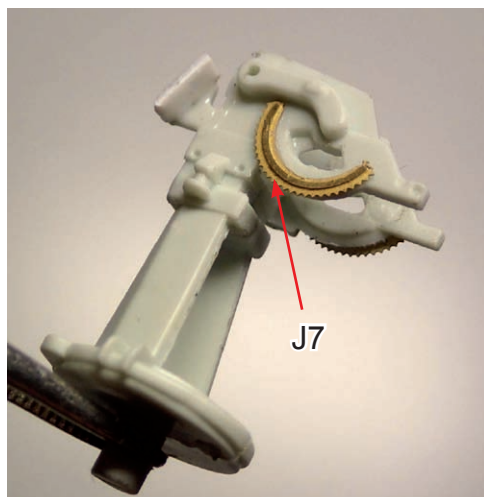

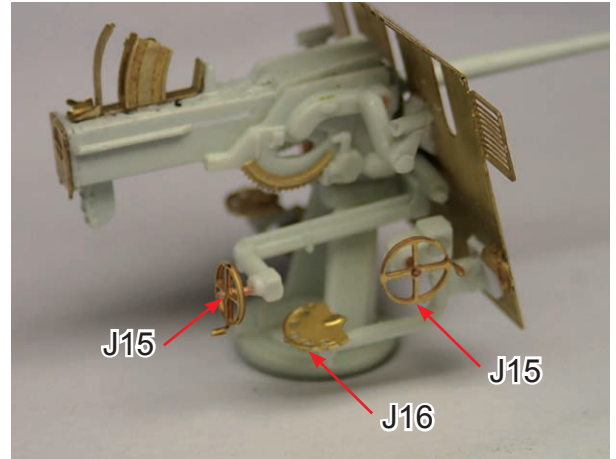
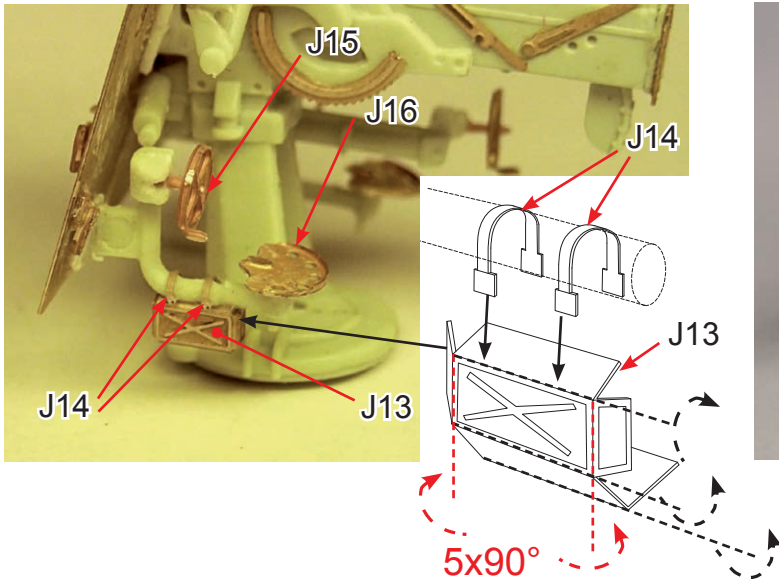

Gun 2x20 mm

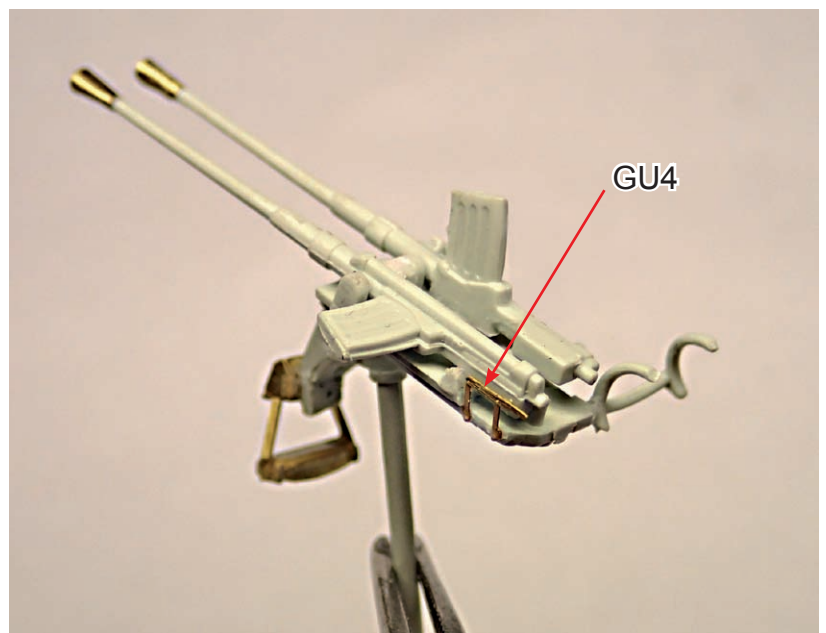
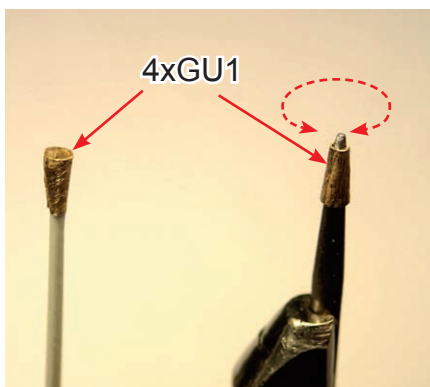
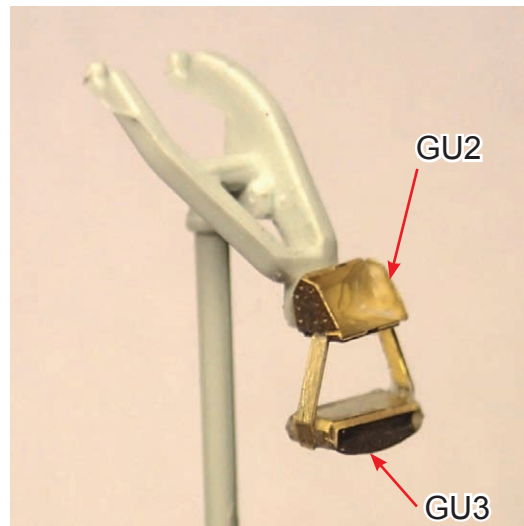
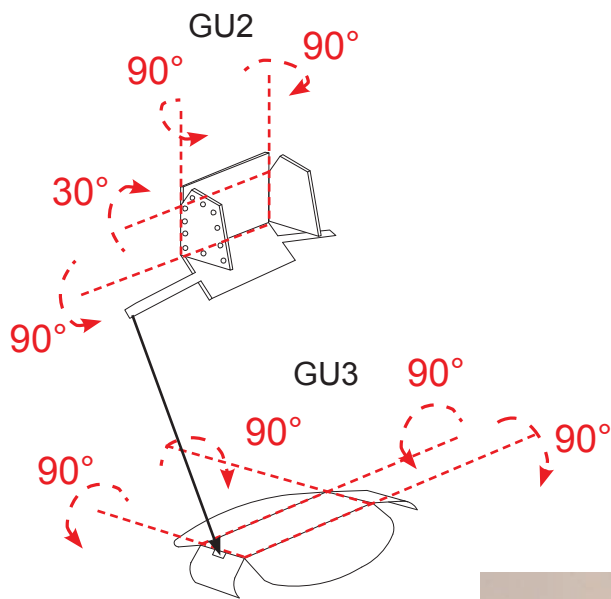

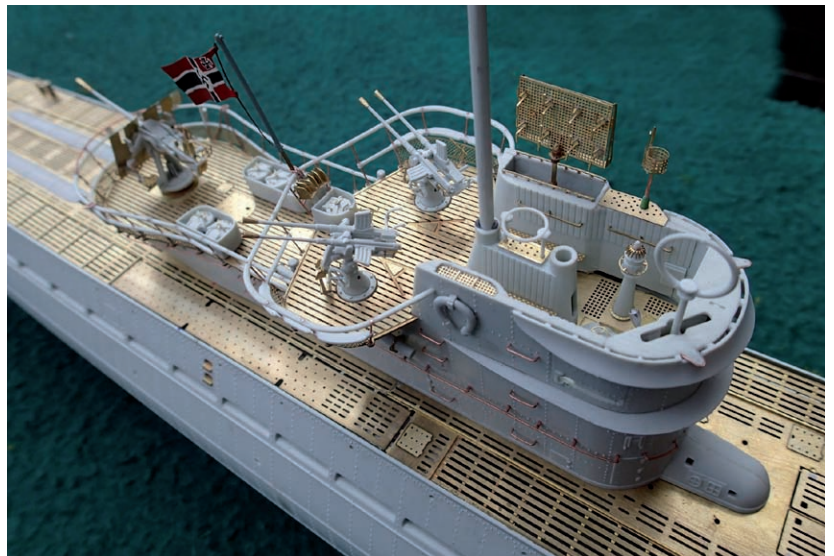
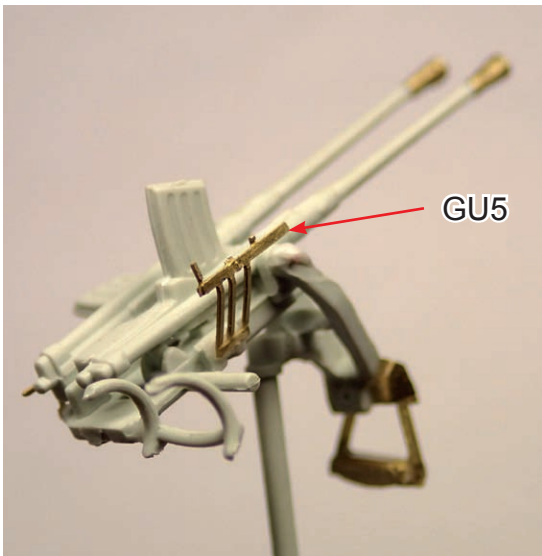

Hull

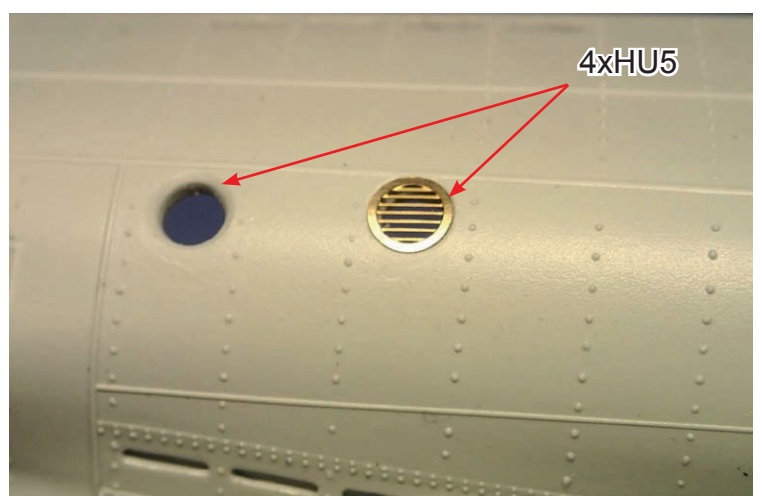
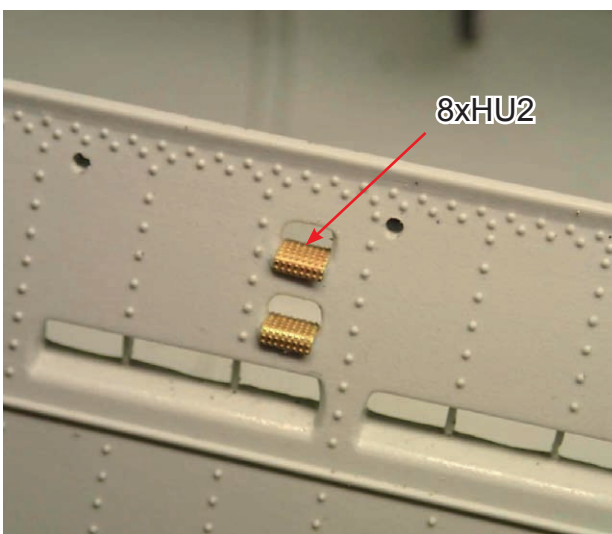
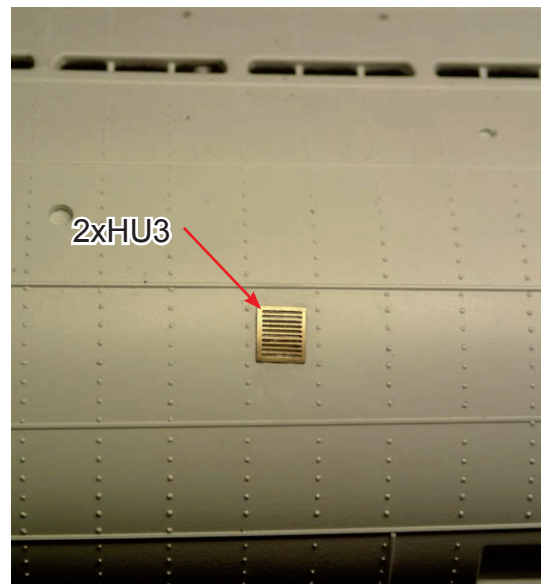
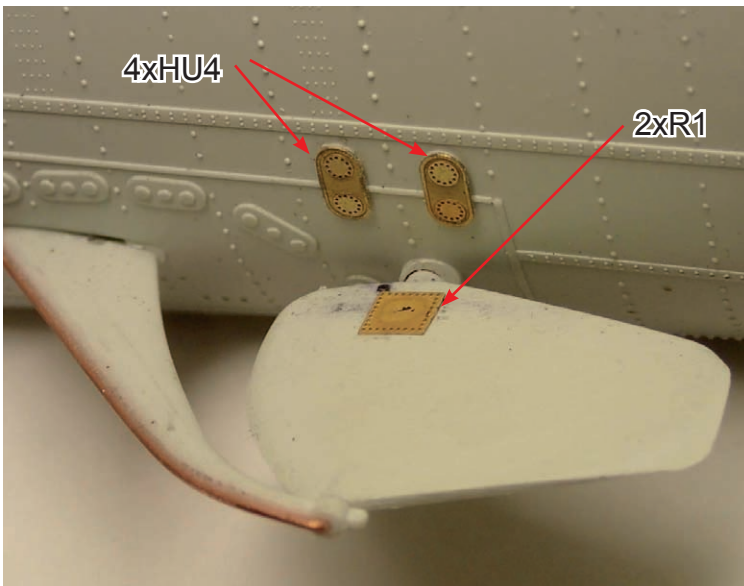



Torpedo hatches (front)

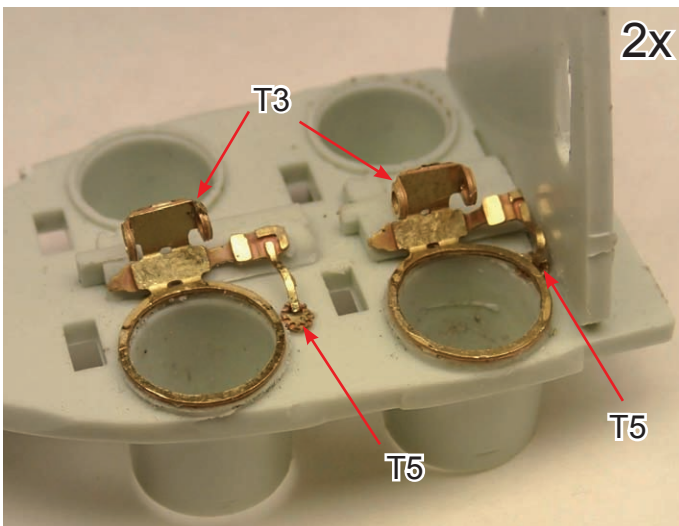
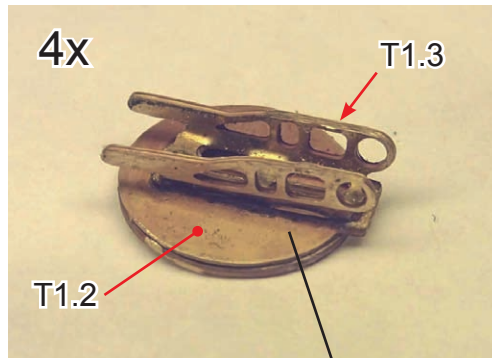
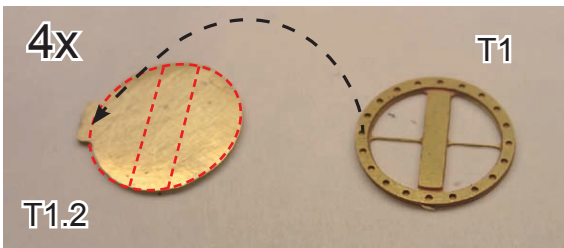
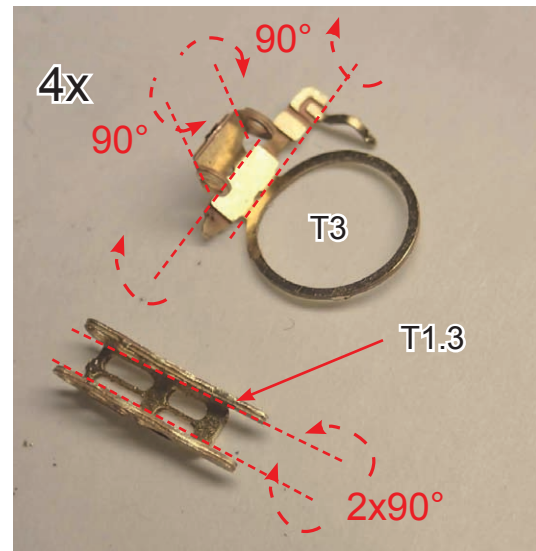

front left tube

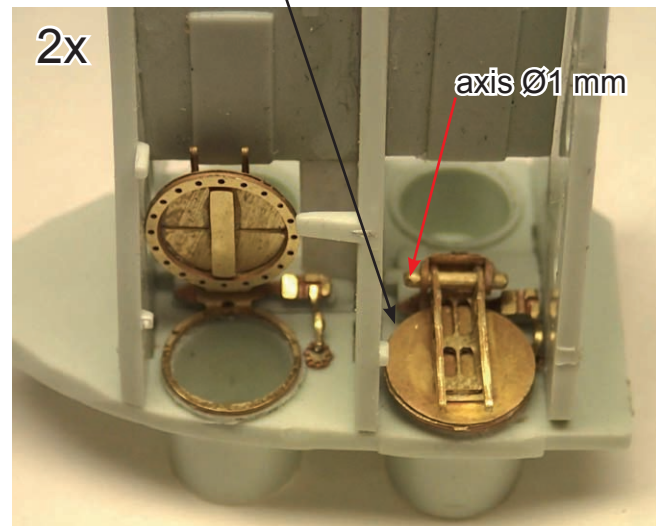

front left tube

Torpedo hatches (back)

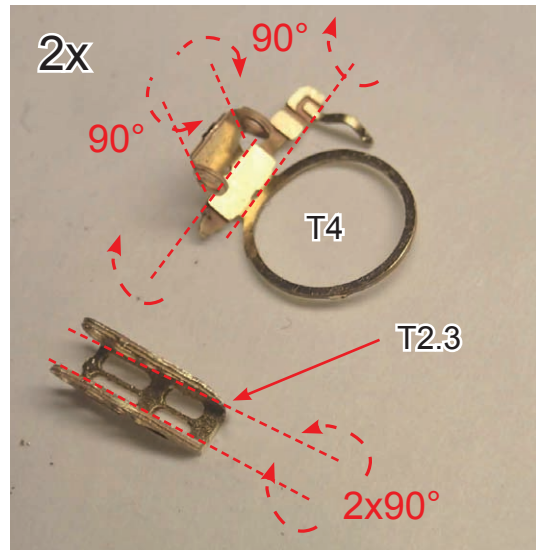

back left tube

back right tube

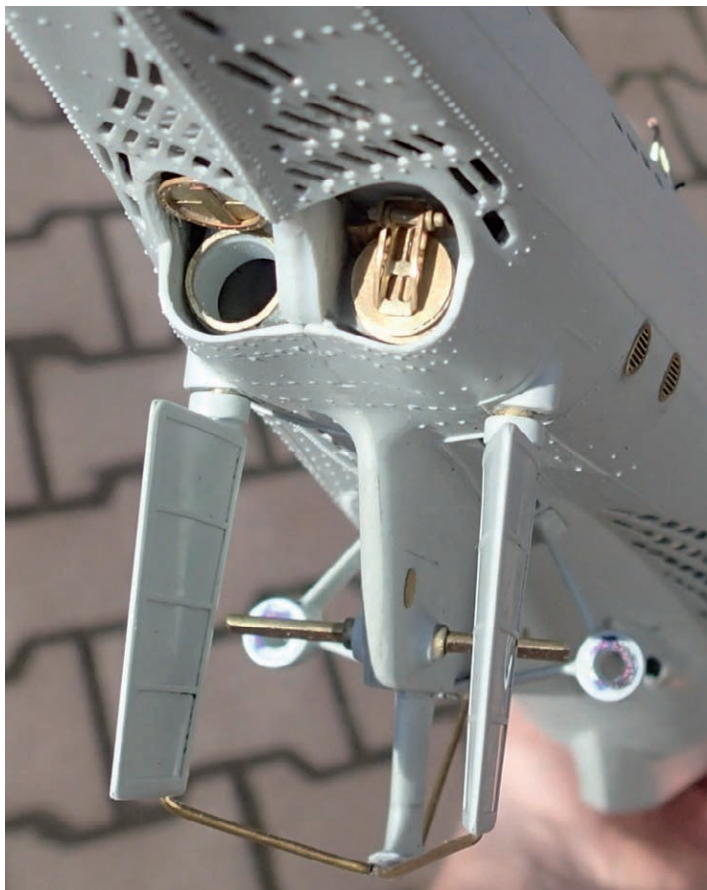

Instructions for Deck gun 105 mm 1/72

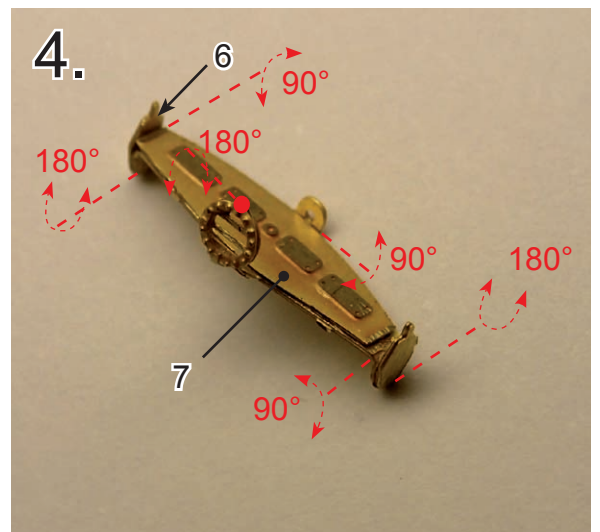
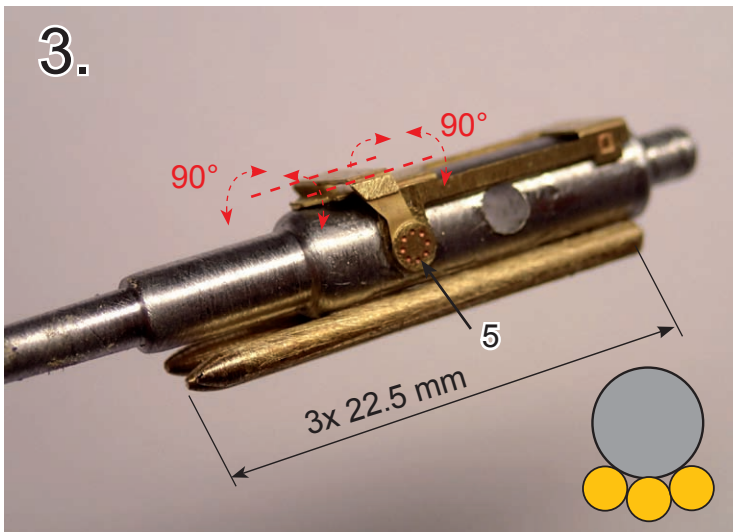
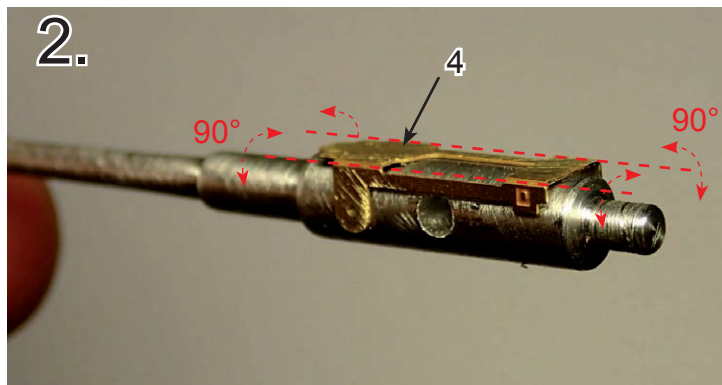
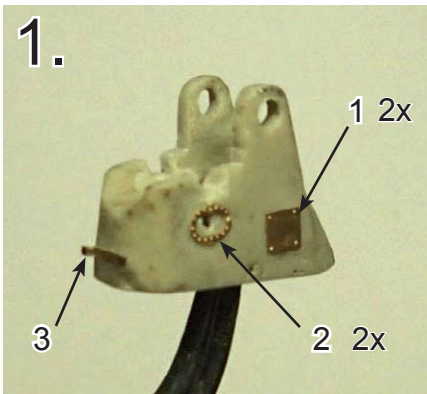
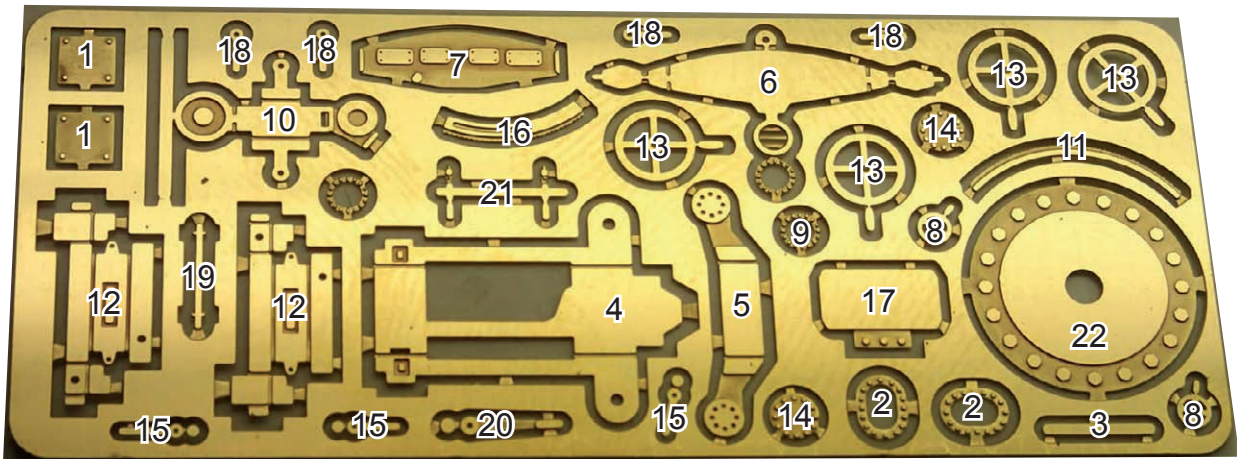
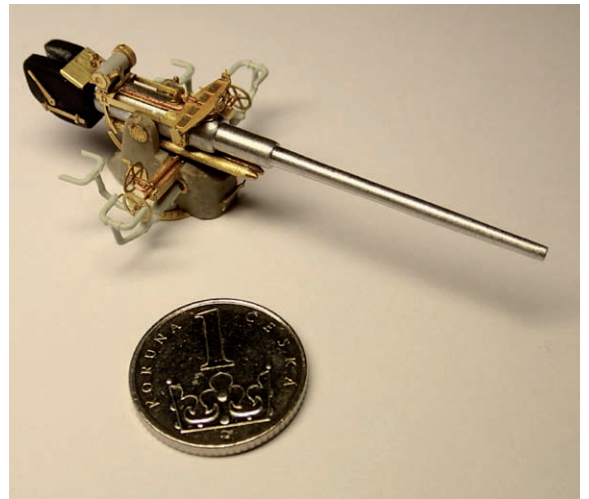
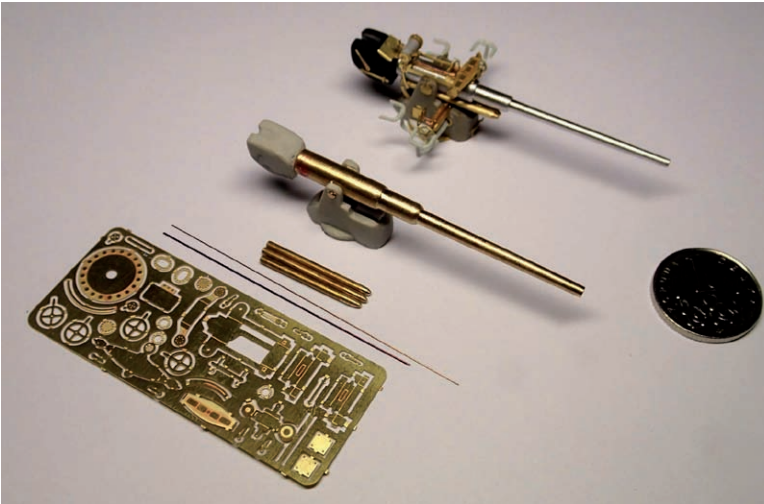

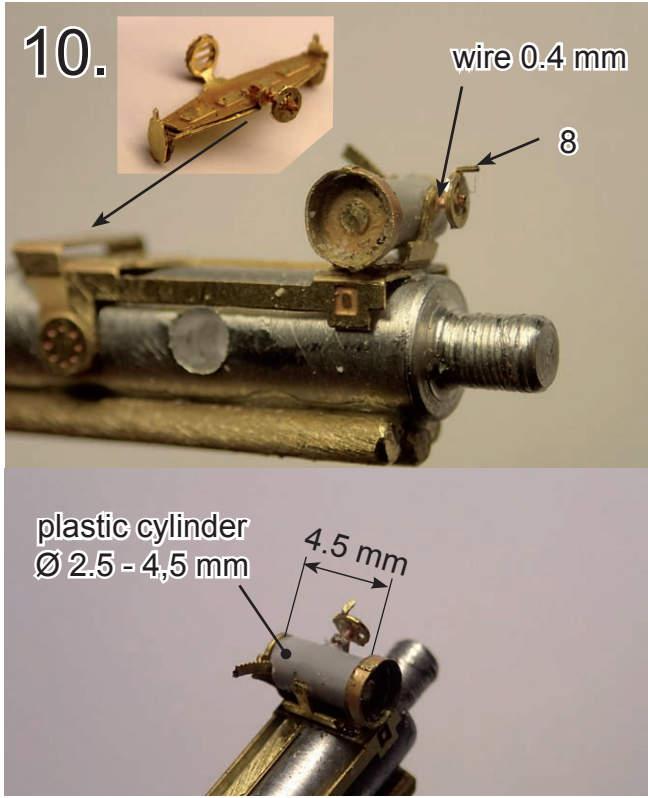
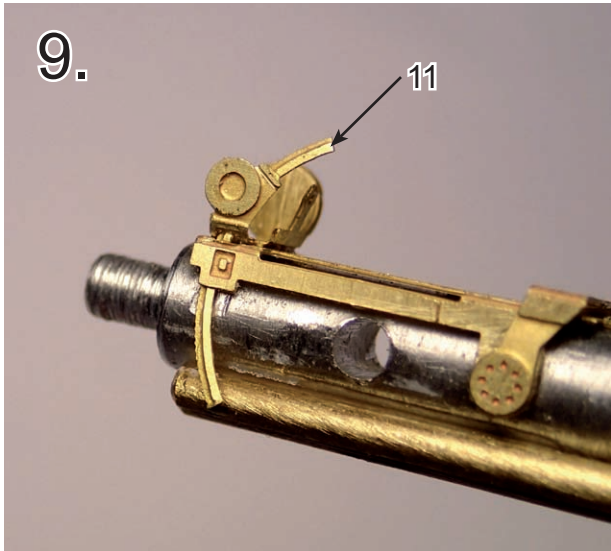
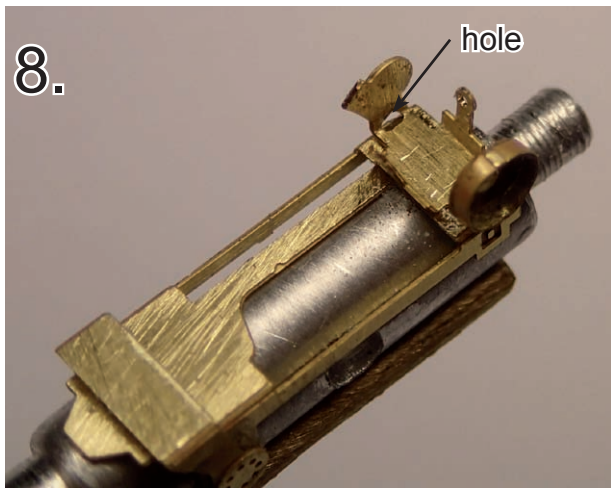
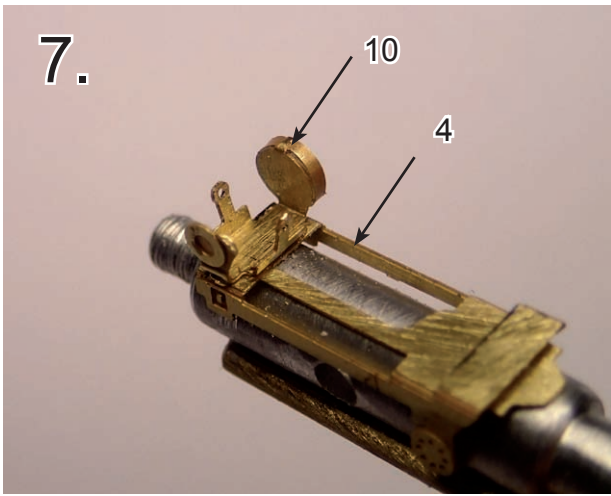
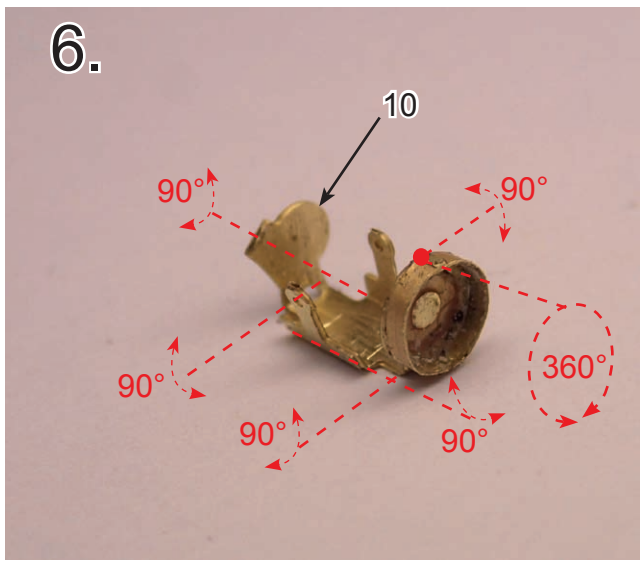
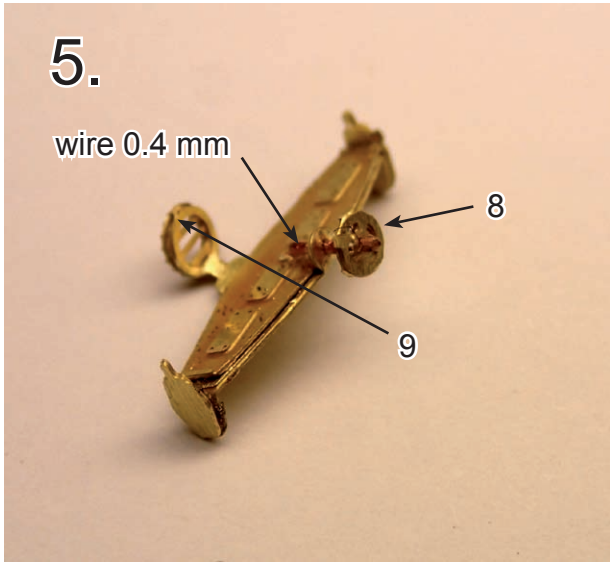

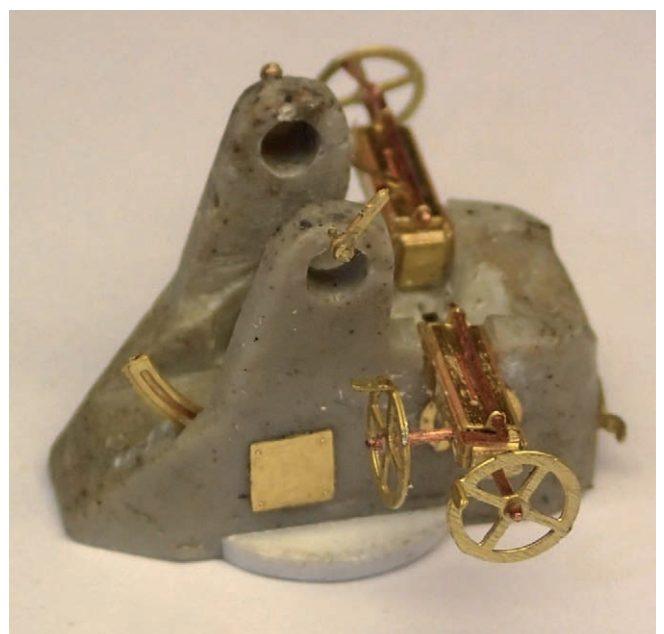
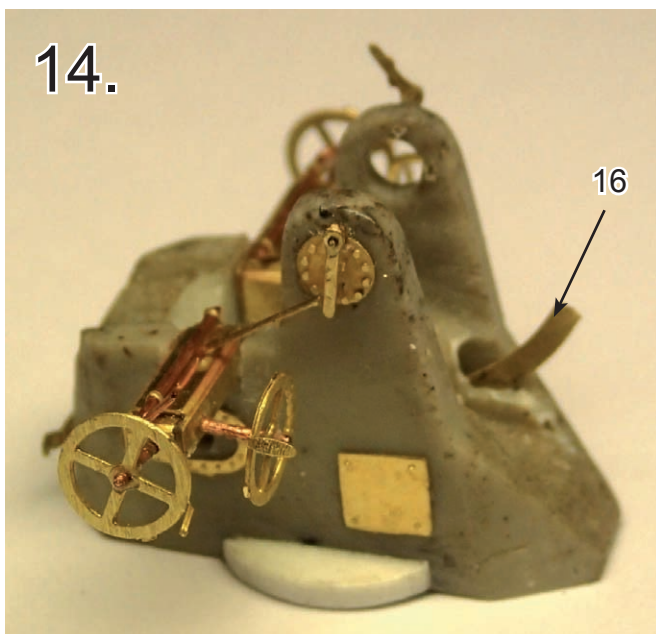
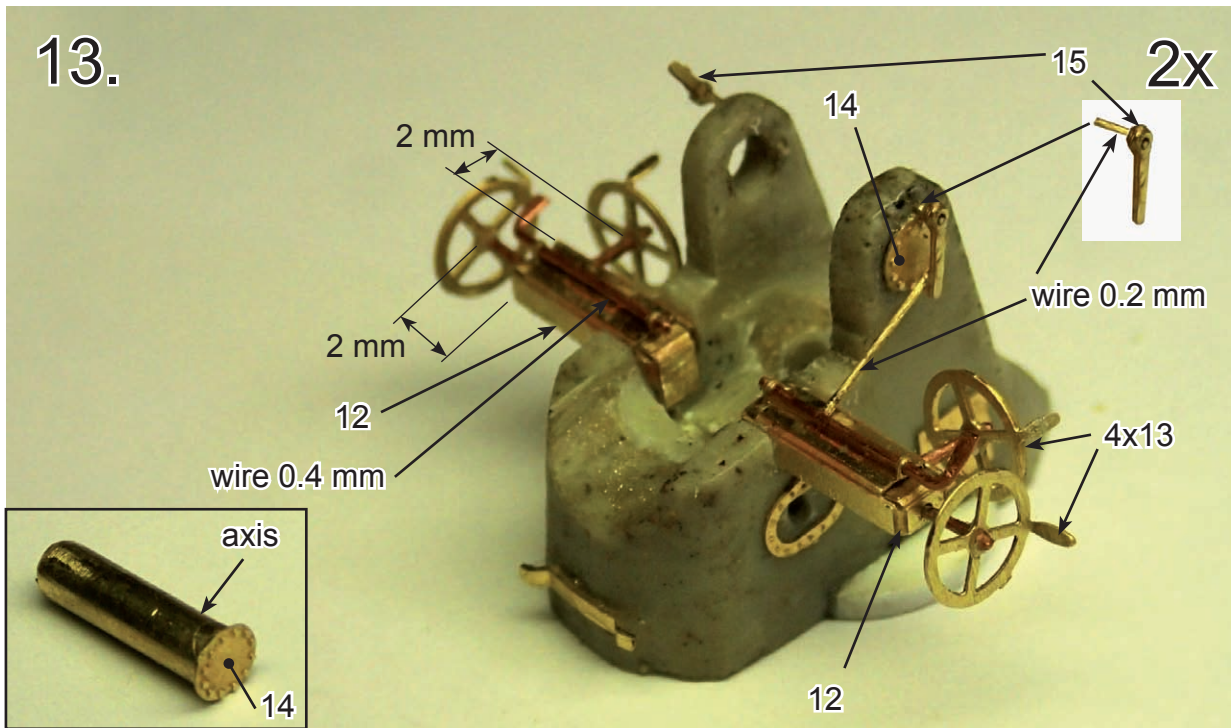
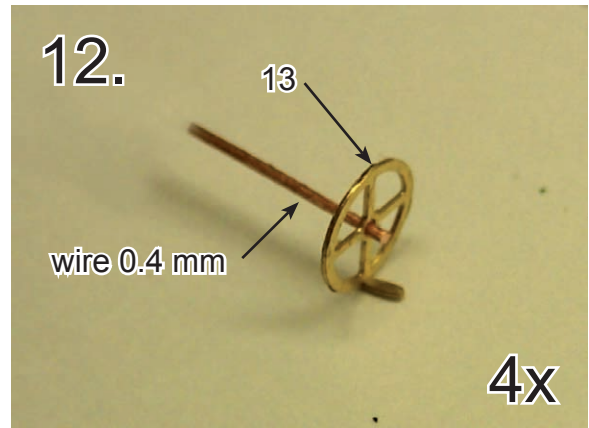
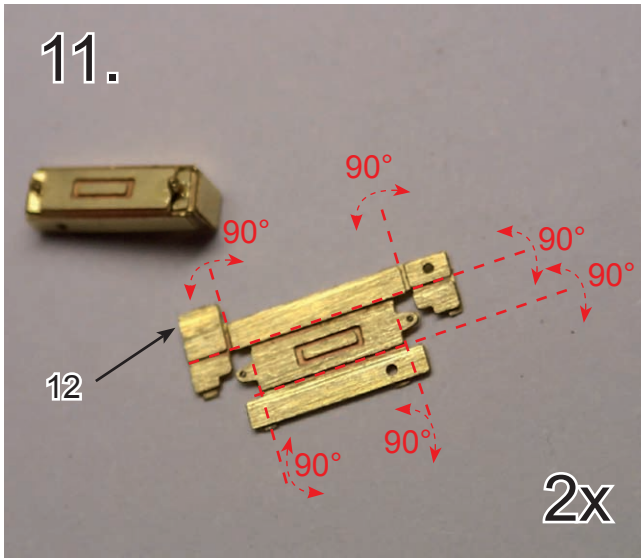



REVELL revell type IX 05114
plastic frame C

